

Product data sheet

Characteristics

GV4L25N6

Motor circuit breaker, TeSys GV4, 3P, 25 A, Icu 50 kA, magnetic, lugs terminals



Main

Range	TeSys
Product name	TeSys GV4
Device short name	GV4L
Product or component type	Circuit breaker
Device application	Motor protection
Poles description	3P
Utilisation category	Category A
Trip unit technology	Magnetic Electronic
Protection type	Short-circuit
[In] rated current	25 A
Breaking capacity	Icu 100 kA at 220...240 V AC 50/60 Hz conforming to IEC 60947-2 Icu 50 kA at 380...415 V AC 50/60 Hz conforming to IEC 60947-2 Icu 50 kA at 440 V AC 50/60 Hz conforming to IEC 60947-2 Icu 15 kA at 525 V AC 50/60 Hz conforming to IEC 60947-2 Icu 8 kA at 660...690 V AC 50/60 Hz conforming to IEC 60947-2 Icu 25 kA at 500 V AC 50/60 Hz conforming to IEC 60947-2
[Ics] rated service breaking capacity	100 KA at 220...240 V AC 50/60 Hz conforming to IEC 60947-2 50 KA at 380...415 V AC 50/60 Hz conforming to IEC 60947-2 50 KA at 440 V AC 50/60 Hz conforming to IEC 60947-2 25 KA at 500 V AC 50/60 Hz conforming to IEC 60947-2 15 KA at 525 V AC 50/60 Hz conforming to IEC 60947-2 2 kA at 660...690 V AC 50/60 Hz conforming to IEC 60947-2
Magnetic setting range	150...350 A
Control type	Rotary handle

The information provided in this documentation contains general descriptions and/or technical characteristics of the products contained herein. This documentation is not intended as a substitute for and is not to be used for determining suitability or reliability of these products for specific user applications. It is the duty of any such user or integrator to perform the appropriate and complete risk analysis, evaluation and testing of the products with respect to the relevant specific application or use thereof. Neither Schneider Electric Industries SAS nor any of its affiliates or subsidiaries shall be responsible or liable for misuse of the information contained herein.

Complementary

[Ue] rated operational voltage	690 V AC 50/60 Hz conforming to IEC 60947-2
Motor power kW	7.5 KW at 660...690 V AC 50/60 Hz 5.5 KW at 400...415 V AC 50/60 Hz 7.5 KW at 500 V AC 50/60 Hz 9 KW at 660...690 V AC 50/60 Hz 11 KW at 660...690 V AC 50/60 Hz 7.5 KW at 400...415 V AC 50/60 Hz 9 KW at 400...415 V AC 50/60 Hz 11 KW at 400...415 V AC 50/60 Hz 9 KW at 500 V AC 50/60 Hz 11 KW at 500 V AC 50/60 Hz 15 KW at 500 V AC 50/60 Hz 15 KW at 660...690 V AC 50/60 Hz 18.5 kW at 660...690 V AC 50/60 Hz
[Uimp] rated impulse withstand voltage	IEC 60947-2 8 kV
[Ui] rated insulation voltage	800 V conforming to IEC 60947-2
Mounting mode	By screws By clips
Mounting support	75 mm symmetrical DIN rail Plate 35 mm symmetrical DIN rail
Suitability for isolation	Yes conforming to IEC 60947-1
Mechanical durability	40000 cycles
Electrical durability	40000 Cycles for AC-3 at 440 V In/2 20000 cycles for AC-3 at 440 V In
Local signalling	Green indicatorpresence of auxiliary contacts:
Number of slots	1 slot(s) for alarm switch for fault signalling contact, plug-in 1 slot(s) for voltage release for electrical remote tripping, plug-in 1 slot(s) for auxiliary switch for open/close contact, plug-in
Toggle padlocking (with accessories)	Padlock in OFF or ON position
Connection pitch	27 mm
Connections - terminals	Lugs-ring terminals
Tightening torque	9 N.M for 16...95 mm ² 5 N.m for 1.5...10 mm ²
Quality labels	CE
Standards	EN/IEC 60947-4-1 EN/IEC 60947-2
Height	155 mm
Width	81 mm
Depth	165 mm
Net weight	1.65 kg
Colour	Grey (RAL 7016)

Environment

Product certifications	IEC CCC EAC EU-RO MR
Tropicalisation	2 conforming to IEC 68-2
IP degree of protection	IP40 front face conforming to IEC 60529
IK degree of protection	IK07 conforming to IEC 62262
Pollution degree	3 conforming to IEC 60947-1
Mechanical robustness	Vibrations: +/- 1 mm 2...13.2 Hz conforming to IEC 60068-2-6 Vibrations: 0.7 gn 13.2...100 Hz conforming to IEC 60068-2-6 Shocks: 15 gn 11 ms conforming to IEC 60068-2-27
Ambient air temperature for operation	-25...70 °C
Ambient air temperature for storage	-50...85 °C
Operating altitude	0...2000 m without derating 2000...5000 m with derating

Packing Units

Package 1 Weight	1.616 kg
Package 1 Height	21.000 cm
Package 1 width	10.500 cm
Package 1 Length	22.000 cm

Offer Sustainability

Sustainable offer status	Green Premium product
EU RoHS Directive	Compliant EU RoHS Declaration
Mercury free	Yes
RoHS exemption information	Yes
China RoHS Regulation	China RoHS Declaration
Environmental Disclosure	Product Environmental Profile
Circularity Profile	End Of Life Information
WEEE	The product must be disposed on European Union markets following specific waste collection and never end up in rubbish bins
PVC free	Yes
Halogen content performance	Halogen free plastic parts product

Contractual warranty

Warranty	18 months
----------	-----------

Tripping Curves for GV4L and GV4LE Combined with Thermal Overload Relay LRD or LR9

Average Operating Times at 20 °C Related to Multiples of the Setting Current

GV4L02 and GV4LE02 to 12 with LRD05 to LRD14, GV4L80 and GV4LE80 with LRD3363

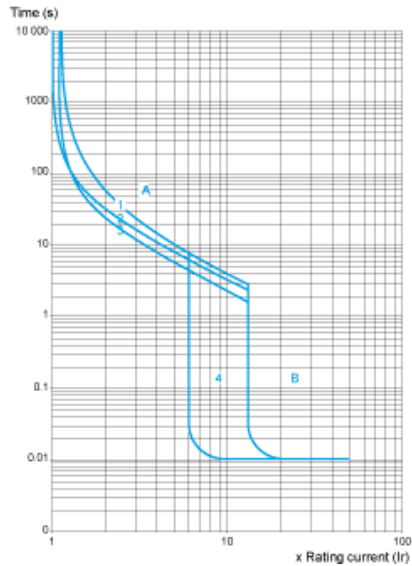

- 1 3 poles from cold state
- 2 2 poles from cold state
- 3 3 poles from hot state
- 4 6...14 Ir
- A Thermal overload relay protection zone
- B GV4L protection zone

GV4L25 and GV4LE25 with LRD 318, LRD325 GV4L50 AND GV4LE50 with LRD 332, LRD 340, LRD 350

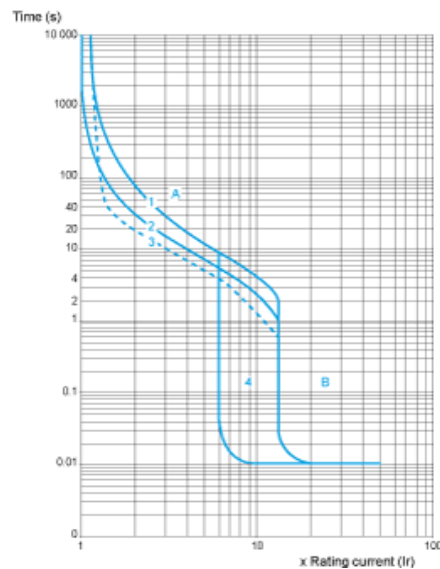

- 1 3 poles from cold state
- 2 2 poles from cold state
- 3 3 poles from hot state
- 4 6...14 Ir
- A Thermal overload relay protection zone
- B GV4L protection zone

GV4L115 and GV4LE115 with Class 10 LR9F5367, LR9D5369 and Class 20 LR9D5567, LR9F5569

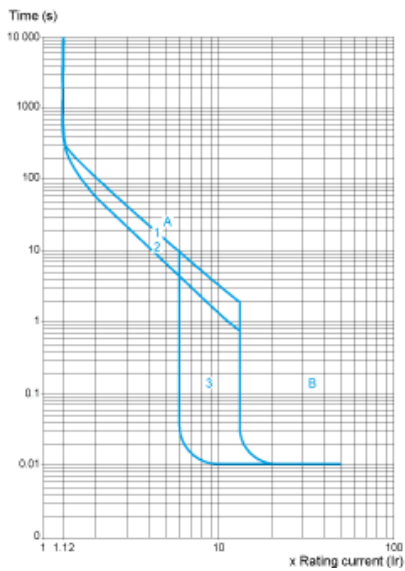

- 1 Cold state curve
- 2 Hot state curve
- 3 6...14 Ir

Current Limitation on Short-Circuit for GV4L, GV4LE (3-Phase 400/415 V)

Dynamic Stress

$I_{peak} = f(\text{prospective } I_{sc}) \text{ at } 1.05 U_e = 435 \text{ V}$

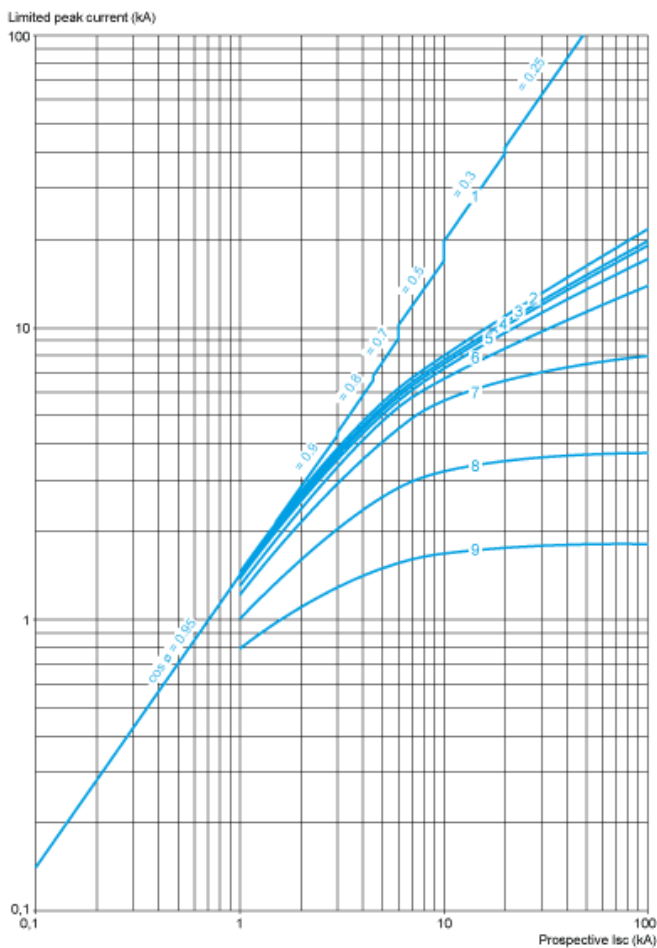

- 1 Maximum peak current
- 2 GV4L115
- 3 GV4L80
- 4 GV4L50
- 5 GV4L25
- 6 GV4L12
- 7 GV4L07
- 8 GV4L03
- 9 GV4L02

Current Limitation on Short-Circuit for GV4L, GV4LE + Thermal Overload Relay LRD or LR9 (3-Phase 400/415 V)

Dynamic Stress

$I_{peak} = f(\text{prospective } I_{sc}) \text{ at } 1.05 U_e = 435 \text{ V}$

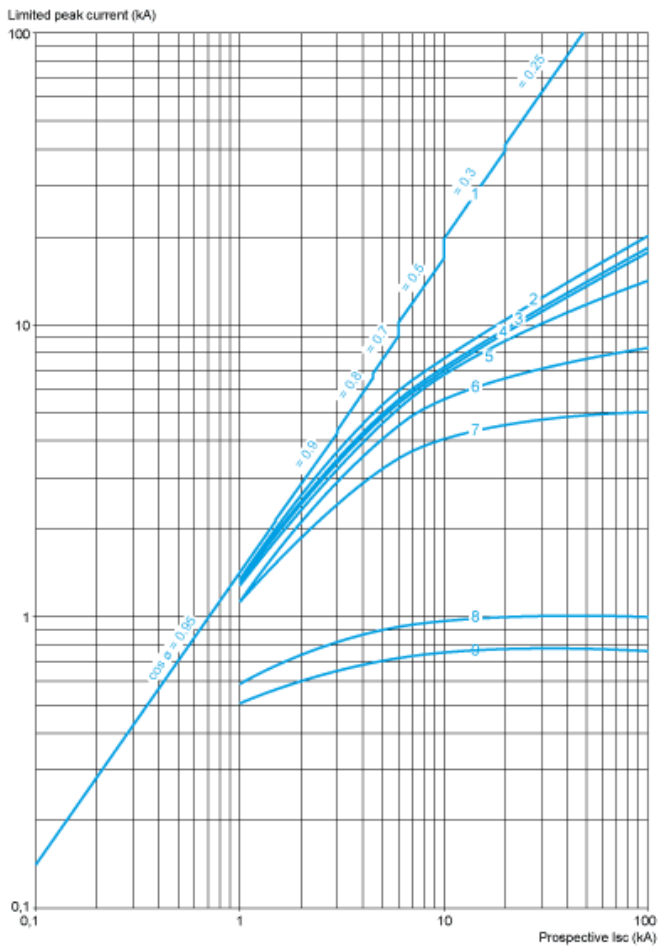

- 1 Maximum peak current
- 2 GV4L115 + LR9D5367 or LR9F5367
- 3 GV4L80 + LRD3361
- 4 GV4L50 + LRD340
- 5 GV4L25 + LRD325
- 6 GV4L12 + LRD313
- 7 GV4L07 + LRD12
- 8 GV4L03 + LRD07
- 9 GV4L02 + LRD07

Thermal Limit on Short-Circuit for GV4L, GV4LE

Thermal Limit in A^2s

$\text{Sum of } I^2 dt = f(\text{prospective } I_{sc}) \text{ at } 1.05 U_e = 435 \text{ V}$

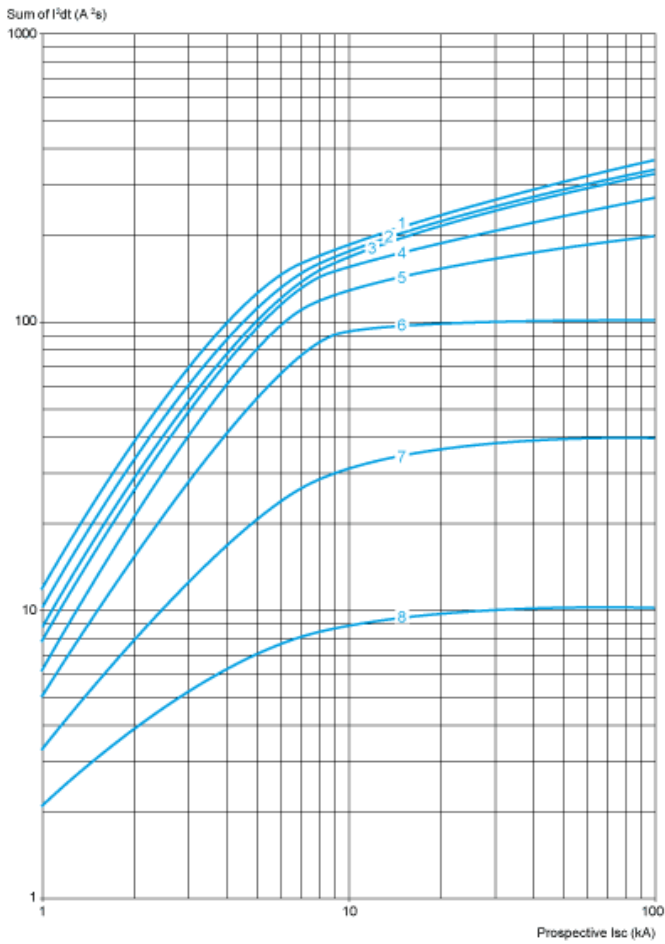

- 1 GV4L115
- 2 GV4L80
- 3 GV4L50
- 4 GV4L25
- 5 GV4L12
- 6 GV4L07
- 7 GV4L03
- 8 GV4L02

Current Limitation on Short-Circuit for GV4L, GV4LE + Thermal Overload Relay LRD or LR9

Thermal Limit in kA in the Magnetic Operating Zone

Sum of $I^2dt = f$ (prospective I_{sc}) at $1.05 U_e = 435 V$

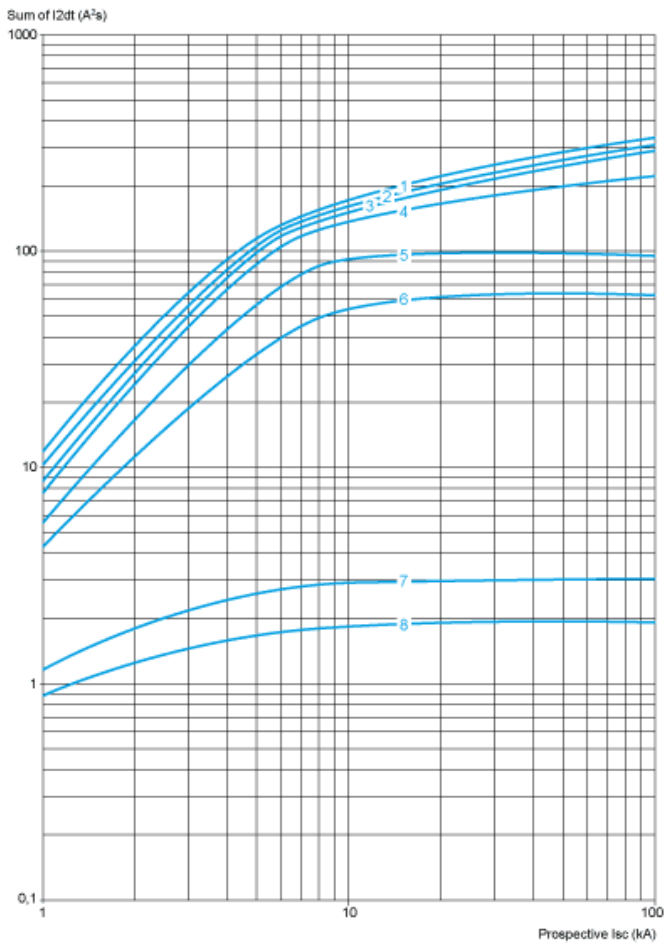

- 1 GV4L115 + LR9D5367 or LR9F5367
- 2 GV4L80 + LRD3361
- 3 GV4L50 + LRD340
- 4 GV4L25 + LRD325
- 5 GV4L12 + LRD313
- 6 GV4L07+ LRD12
- 7 GV4L03+ LRD07
- 8 GV4L02 + LRD07

GV4 with Toggle: GV4LE, GV4PE, GV4PEM

With EverLink® Connector

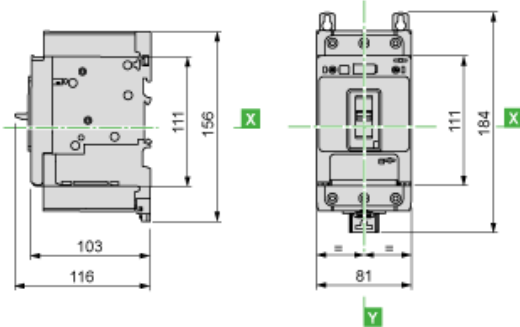

With Crimp Lug Connector

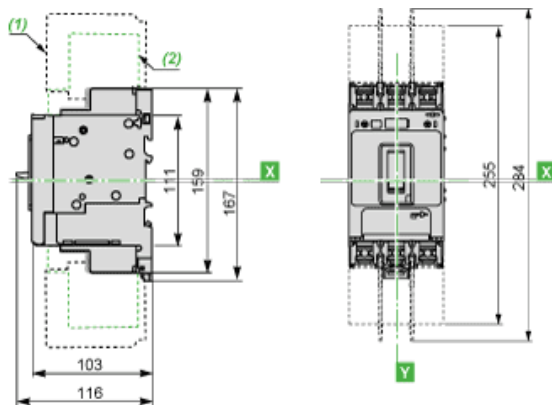

- (1) Interphases barriers
- (2) Long terminal shield

GV4 with Rotary Handle: GV4L, GV4P, or GV4LE, GV4PE, GV4PEM with GV4ADN01, GV4ADN02 Direct Mounting Rotary Handle

Dimensions

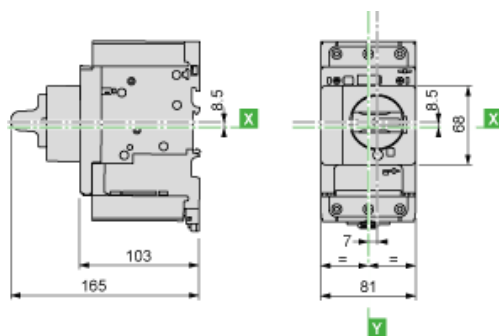

GV4L, GV4P, GV4LE, GV4PE, GV4PEM

Panel Mounting with M4 Screws

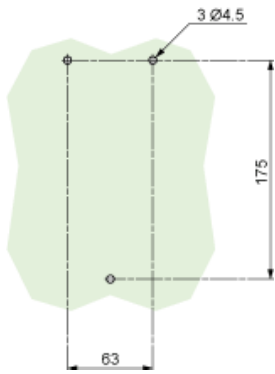

Door Cut-Out for Rotary Handle

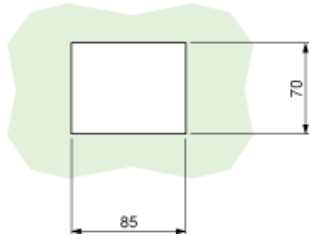

Minimum Safety Clearance

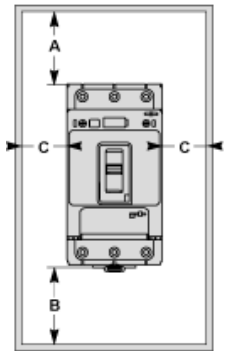

Toggle-type, rotary handle-type: identical clearance values.

Safety Clearance (mm)						
	Painted Sheet Metal			Bare Sheet Metal		
	A	B	C	A	B	C
No accessory	30	0	0	40	0	5
Interphase barriers	0	0	0	0	0	5
Long terminal shield	0	0	0	0	0	5

Magnetic Motor Circuit Breakers

GV4L, GV4LE

