

Product data sheet

Characteristics

GV4PEM80N

Motor circuit breaker, TeSys GV4, 3P, 80A, Icu 50kA, thermal magnetic multifunction, Everlink terminals





Main

Range	TeSys
Product name	TeSys GV4
Device short name	GV4PEM
Product or component type	Multifunction circuit breaker
Device application	Motor protection
Protection type	Locked rotor Phase unbalance Short time short-circuit protection Long start Overload Phase loss Jam Ground fault protection Short-circuit
Utilisation category	Category A
Suitability for isolation	Yes conforming to IEC 60947-1
Poles description	3P
[Ue] rated operational voltage	690 V AC 50/60 Hz conforming to IEC 60947-2
[In] rated current	80 A
Trip unit technology	Thermal-magnetic Electronic
Magnetic tripping current	1360 A
[I _{sd}] short-time pick-up adjustment range	5...13 x I _r
Thermal protection adjustment range	40...80 A
Motor tripping class	10 20
Phase failure sensitivity	Yes conforming to IEC 60947-4-1
Breaking capacity	I _{cu} 100 kA at 220...240 V AC 50/60 Hz conforming to IEC 60947-2 I _{cu} 50 kA at 380...415 V AC 50/60 Hz conforming to IEC 60947-2 I _{cu} 50 kA at 440 V AC 50/60 Hz conforming to IEC 60947-2 I _{cu} 15 kA at 525 V AC 50/60 Hz conforming to IEC 60947-2 65 KA at 208Y/120 V AC 50/60 Hz conforming to UL 60947 65 KA at 240 V AC 50/60 Hz conforming to UL 60947 35 KA at 480Y/277 V AC 50/60 Hz conforming to UL 60947 I _{cu} 8 kA at 660...690 V AC 50/60 Hz conforming to IEC 60947-2 I _{cu} 25 kA at 500 V AC 50/60 Hz conforming to IEC 60947-2 18 kA at 600Y/347 V AC 50/60 Hz conforming to UL 60947
[I _{cs}] rated service breaking capacity	100 KA at 220...240 V AC 50/60 Hz conforming to IEC 60947-2 50 KA at 380...415 V AC 50/60 Hz conforming to IEC 60947-2 50 KA at 440 V AC 50/60 Hz conforming to IEC 60947-2 25 KA at 500 V AC 50/60 Hz conforming to IEC 60947-2 15 KA at 525 V AC 50/60 Hz conforming to IEC 60947-2 2 kA at 660...690 V AC 50/60 Hz conforming to IEC 60947-2
[U _{imp}] rated impulse withstand voltage	IEC 60947-2 8 kV

[Ui] rated insulation voltage	800 V conforming to IEC 60947-2
Mechanical durability	40000 cycles
Electrical durability	14000 Cycles for AC-3 at 440 V In/2 7000 cycles for AC-3 at 440 V In

Complementary

Motor power kW	37 KW at 400...415 V AC 50/60 Hz 45 KW at 500 V AC 50/60 Hz 22 KW at 400...415 V AC 50/60 Hz 30 KW at 500 V AC 50/60 Hz 37 KW at 660...690 V AC 50/60 Hz 45 KW at 660...690 V AC 50/60 Hz 55 KW at 660...690 V AC 50/60 Hz 30 KW at 400...415 V AC 50/60 Hz 37 kW at 500 V AC 50/60 Hz
Control type	Toggle
Handle padlocking	With a lock accessory
Number of slots	1 slot(s) for alarm switch for fault signalling contact, plug-in 1 slot(s) for voltage release for electrical remote tripping, plug-in 1 slot(s) for auxiliary switch for open/close contact, plug-in
Local signalling	Flashing LED (green)ready: LED (red)alarm (T° >95%): Green indicatorpresence of auxiliary contacts:
Communication port protocol	NFC
Standards	CSA C22.2 No 60947-4-1 UL 60947-4-1 EN/IEC 60947-2 EN/IEC 60947-4-1
Product certifications	IEC UL CSA CCC EAC ATEX EU-RO MR
Quality labels	CE
Mounting mode	By clips By screws
Mounting support	75 mm symmetrical DIN rail 35 mm symmetrical DIN rail Plate
Connections - terminals	Top 1 EverLink BTR screw connectors wire size 1.5...70 mm ² , solid Top 1 EverLink BTR screw connectors wire size 1.5...50 mm ² , flexible Bottom 1 EverLink BTR screw connectors wire size 2.5...95 mm ² , solid Bottom 1 EverLink BTR screw connectors wire size 2.5...70 mm ² , flexible
Connection pitch	27 mm
Wire stripping length	20 mm
Tightening torque	9 N.M for 16...95 mm ² 5 N.m for 1.5...10 mm ²
Width	81 mm
Height	155 mm
Depth	116 mm
Net weight	1.45 kg
Colour	Grey (RAL 7016)

Environment

Ambient air temperature for storage	-50...85 °C
Ambient air temperature for operation	-25...70 °C
Operating altitude	0...2000 m without derating 2000...5000 m with derating
IP degree of protection	IP40 front face conforming to IEC 60529
IK degree of protection	IK07 conforming to IEC 62262
Pollution degree	3 conforming to IEC 60947-1

Tropicalisation	2 conforming to IEC 68-2
Mechanical robustness	Vibrations: +/- 1 mm 2...13.2 Hz conforming to IEC 60068-2-6 Vibrations: 0.7 gn 13.2...100 Hz conforming to IEC 60068-2-6 Shocks: 15 gn 11 ms conforming to IEC 60068-2-27

Packing Units

Unit Type of Package 1	PCE
Number of Units in Package 1	1
Package 1 Weight	1.67 kg
Package 1 Height	11 cm
Package 1 width	17 cm
Package 1 Length	22 cm
Unit Type of Package 2	S03
Number of Units in Package 2	5
Package 2 Weight	9 kg
Package 2 Height	30 cm
Package 2 width	30 cm
Package 2 Length	40 cm
Unit Type of Package 3	PAL
Number of Units in Package 3	48
Package 3 Weight	106 kg
Package 3 Height	110 cm
Package 3 width	80 cm
Package 3 Length	120 cm

Offer Sustainability

Sustainable offer status	Green Premium product
EU RoHS Directive	Compliant EU RoHS Declaration
Mercury free	Yes
RoHS exemption information	Yes
China RoHS Regulation	China RoHS Declaration
Environmental Disclosure	Product Environmental Profile
Circularity Profile	End Of Life Information
WEEE	The product must be disposed on European Union markets following specific waste collection and never end up in rubbish bins
PVC free	Yes
Halogen content performance	Halogen free plastic parts product

Contractual warranty

Warranty	18 months
----------	-----------

Thermal-Magnetic Tripping Curves for GV4P, GV4PE, GV4PEM

Average Operating Times at 20 °C Related to Multiples of the Setting Current

Hot state

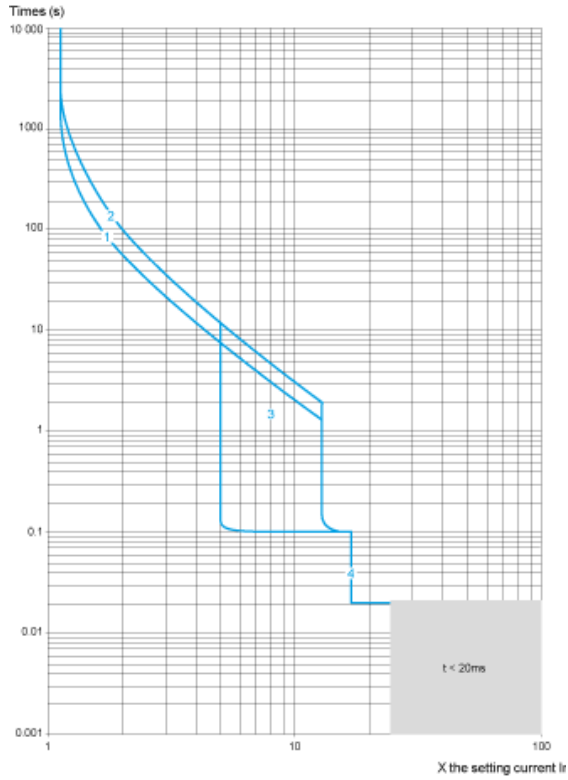

- 1 Class 10
- 2 Class 20
- 3 $I_{sd} = 5...13 \times I_r$
- 4 $I_{li} = 17 I_n$

Cold state

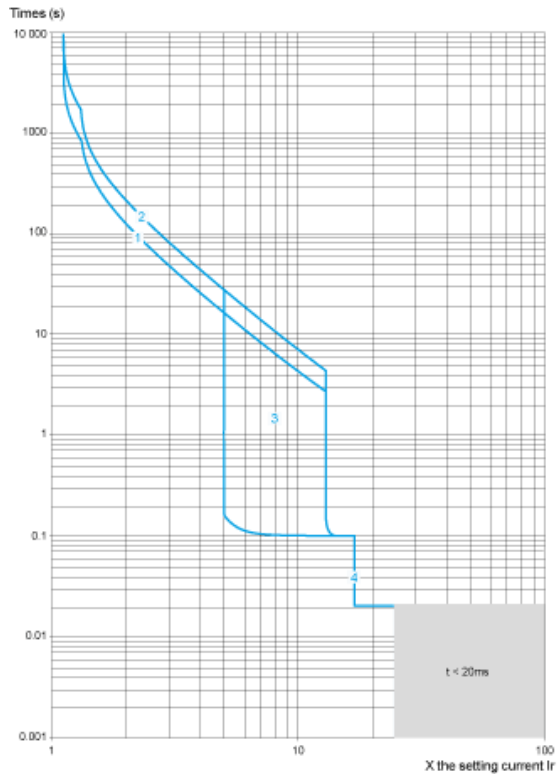

- 1 Class 10
- 2 Class 20
- 3 $I_{sd} = 5 \dots 13 \times I_r$
- 4 $I_i = 17 I_n$

Current Limitation on Short-Circuit for GV4P, GV4PE, GV4PEM (3-Phase 400/415 V)

Dynamic Stress

$I_{peak} = f(\text{prospective } I_{sc}) \text{ at } 1.05 U_e = 435 \text{ V}$

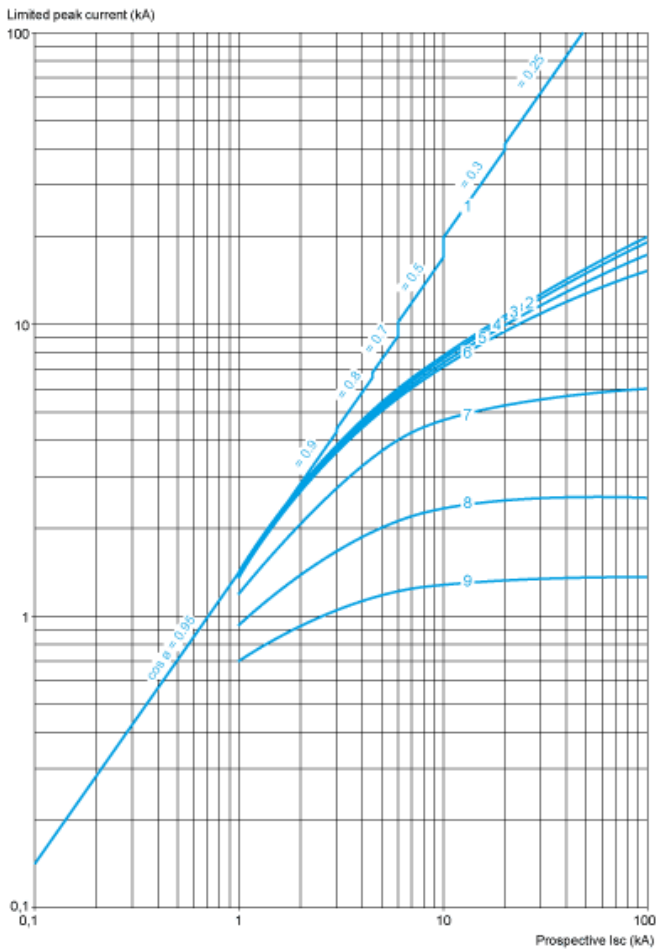

- 1 Maximum peak current
- 2 GV4P115
- 3 GV4P80
- 4 GV4P50
- 5 GV4P25
- 6 GV4P12
- 7 GV4P07
- 8 GV4P03
- 9 GV4P02

Thermal Limit on Short-Circuit for GV4P, GV4PE, GV4PEM

Thermal Limit in kA^2s in the Magnetic Operating Zone

Sum of $I^2dt = f$ (prospective Isc) at $1.05 U_e = 435 V$

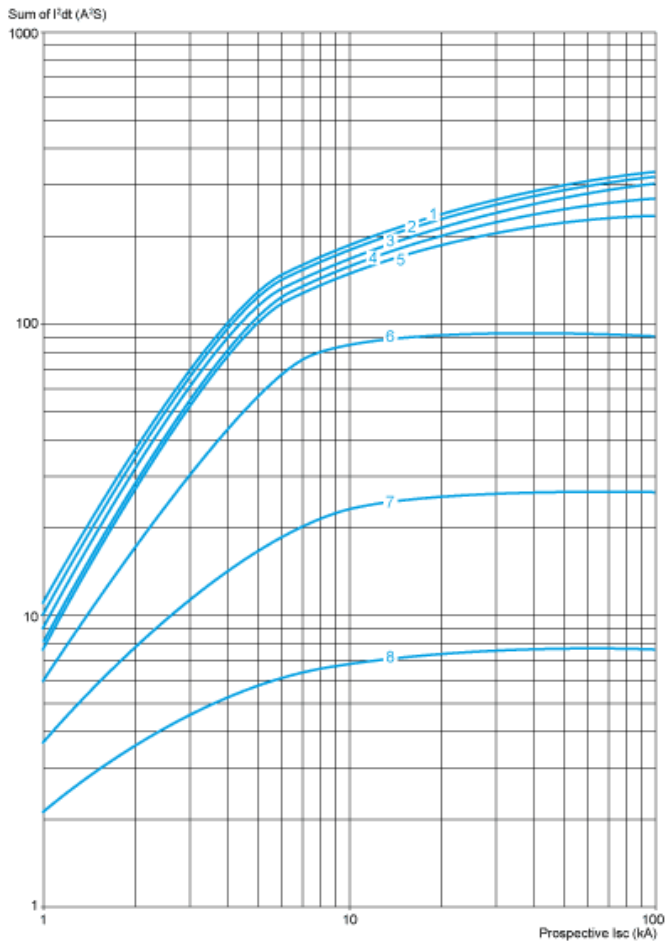

- 1 GV4P115
- 2 GV4P80
- 3 GV4P50
- 4 GV4P25
- 5 GV4P12
- 6 GV4P07
- 7 GV4P03
- 8 GV4P02

GV4 with Toggle: GV4LE, GV4PE, GV4PEM

With EverLink® Connector

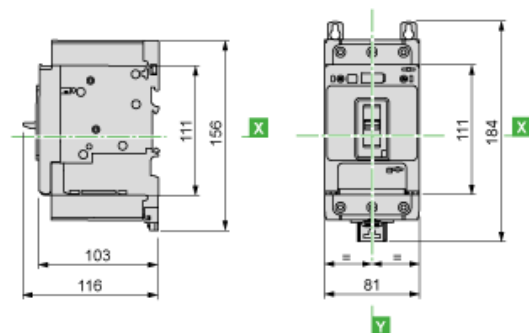

With Crimp Lug Connector

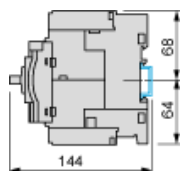

GV4 with Rotary Handle: GV4L, GV4P, or GV4LE, GV4PE, GV4PEM with GV4ADN01, GV4ADN02 Direct Mounting Rotary Handle

Dimensions

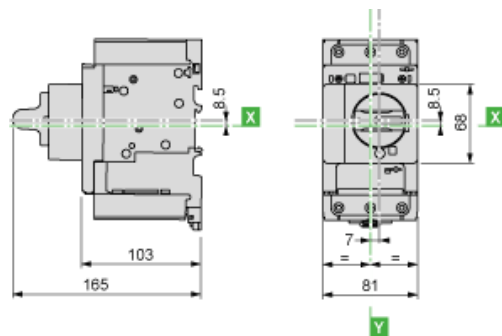

GV4L, GV4P, GV4LE, GV4PE, GV4PEM

Panel Mounting with M4 Screws

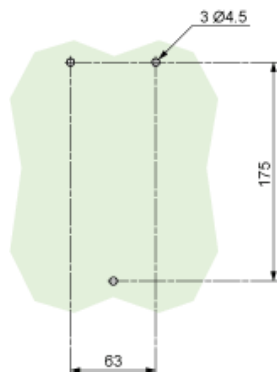

Door Cut-Out for Rotary Handle

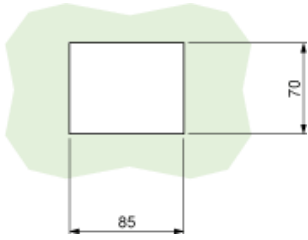

Minimum Safety Clearance

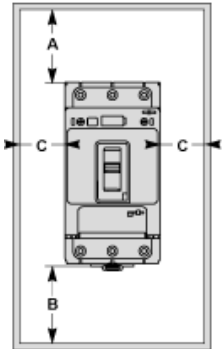

Toggle-type, rotary handle-type: identical clearance values.

Safety Clearance (mm)						
	Painted Sheet Metal			Bare Sheet Metal		
	A	B	C	A	B	C
No accessory	30	0	0	40	0	5
Interphase barriers	0	0	0	0	0	5
Long terminal shield	0	0	0	0	0	5

Magnetic Motor Circuit Breakers

GV4P, GV4PE, GV4PEM

