



## Teknisk informasjon

Produktspekter	Harmony XB4
Produkt eller type komponent	Hode for lysvendere
Produktkompatibilitet	Universal LED
Kortnavn utstyr	ZB4
Innfatningsmateriale	Forkrommet metall
Hode type	Standard
Montasjediameter	22 mm
Salg per udelelig kvantitet	1
Formen på varslingsenhetens hode	Rund
Type arm/stempel	Til senter fjærretur
Operatørprofil	Blå standard grep
Informasjon om knappens stilling	3 posisjoner +/- 45°

## Komplementær

Bredde	29 mm
Høyde	29 mm
Dybde	43 mm
Vekt	0,036 kg
Resistens til høytrykksvask	7000000 Pa på 55 °C, distanse : 0.1 m
Mekanisk levetid	500000 sykluser
Elektrisk sammensetningskode	M3 for <4 kontakter bruker Enkel blokker i frontmontering med innebygget LED M6 for <2 kontakter bruker Enkel blokker i frontmontering med integrert LED og transformator M10 for <2 kontakter bruker Enkel blokker i frontmontering med innebygget LED M4 for <4 kontakter bruker enkel og dobbel blokker i frontmontering med innebygget LED
Enhetens utseende	Basic element

## Miljø

Overflatebeskyttelse	TH
Omgivelsestemperatur for lagring	-40...70 °C
Omgivelsestemperatur drift	-40...70 °C
Overspenningskategori	Klasse I i samsvar med IEC 60536
IP-grad	IP66 i samsvar med IEC 60529 IP67 IP69 IP69K
NEMA beskyttelsesgrad	NEMA 13 NEMA 4X
IK beskyttelsesklasse	IK06 i samsvar med IEC 50102
Standarder	UL 508 EN/IEC 60947-1 CSA C22.2 No 14 JIS C8201-5-1 EN/IEC 60947-5-1 EN/IEC 60947-5-4 EN/IEC 60947-5-5 JIS C8201-1

Produktsertifikater	LROS (Lloyds register of shipping) UL listet BV CSA GL DNV
Vibrasjonsmotstand	5 gn (f= 2...500 Hz) i samsvar med IEC 60068-2-6
Støtmotstand	30 gn (varighet = 18 ms) for halvsinusurve akselerasjon i samsvar med IEC 60068-2-27 50 gn (varighet = 11 ms) for halvsinusurve akselerasjon i samsvar med IEC 60068-2-27

### Forpakkingsinformasjon

Enhetstype pakke 1	PCE
Antall enheter i pakke 1	1
Pakke 1 Høyde	3,6 cm
Pakke 1 Bredd	5,4 cm
Pakke 1 Vekt	5,9 cm
Package 1 Weight	41,7 g
Enhetstype pakke 2	S03
Antall enheter i pakke 2	250
Pakke 2 Høyde	30 cm
Pakke 2 Bredd	30 cm
Pakke 2 Lengde	40 cm
Pakke 2 Vekt	10,902 kg

### Bærekraftig

Produktets miljøstatus	Green Premium miljømerket produkt
REACH-regelverk	<a href="#">REACH-erklæring</a>
REACH fri for SVHC	Ja
EU RoHS-direktiv	Proaktivt i samsvar (Produktet inngår ikke i EUs RoHS direktivet) <a href="#">EU RoHS-erklæring</a>
Fri for giftige tungmetaller	Ja
Kvikksølvfri	Ja
Kinas RoHS-forskrift	<a href="#">Kinas RoHS-Erklæring</a>
Informasjon om RoHS-unntak	<a href="#">Ja</a>
Miljøinformasjon	<a href="#">Produktmiljøprofil</a>
Produktets livssyklus	<a href="#">Informasjon Om Levetidsslutt</a>

### Garantiperiode

Garanti	18 months
---------	-----------

---

Dimensions

---

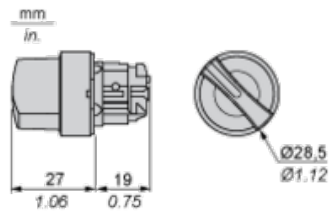

Panel Cut-out for Pushbuttons, Switches and Pilot Lights (Finished Holes, Ready for Installation)

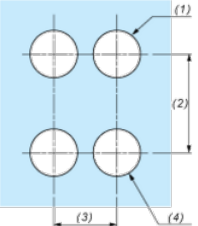
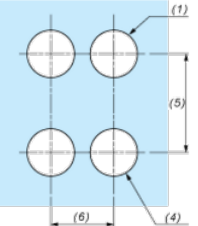
Connection by Screw Clamp Terminals or Plug-in Connectors or on Printed Circuit Board	Connection by Faston Connectors
	
<p>(1) Diameter on finished panel or support                  (2) 40 mm min. / 1.57 in. min.                  (3) 30 mm min. / 1.18 in. min.                  (4) <math>\varnothing 22.5</math> mm / 0.89 in. recommended (<math>\varnothing 22.3</math> mm <math>_0^{+0.4}</math> / 0.88 in. <math>_0^{+0.016}</math>)                  (5) 45 mm min. / 1.78 in. min.                  (6) 32 mm min. / 1.26 in. min.</p>	

Pushbuttons, Switches and Pilot Lights for Printed Circuit Board Connection

Panel Cut-outs (Viewed from Installer's Side)

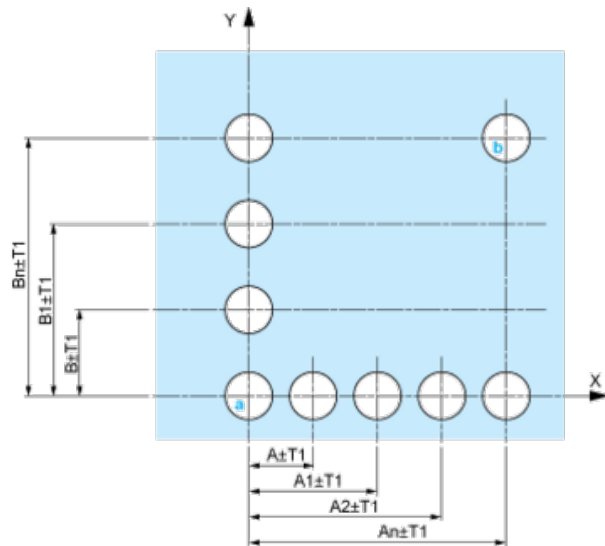

A: 30 mm min. / 1.18 in. min.  
 B: 40 mm min. / 1.57 in. min.

Printed Circuit Board Cut-outs (Viewed from Electrical Block Side)

Dimensions in mm



A: 30 mm min.  
 B: 40 mm min.  
 Dimensions in in.



A: 1.18 in. min.  
 B: 1.57 in. min.

### General Tolerances of the Panel and Printed Circuit Board

The cumulative tolerance must not exceed 0.3 mm / 0.012 in:  $T1 + T2 = 0.3 \text{ mm max.}$

### Installation Precautions

- Minimum thickness of circuit board: 1.6 mm / 0.06 in.
- Cut-out diameter: 22.4 mm  $\pm$  0.1 / 0.88 in.  $\pm$  0.004
- Orientation of body/fixing collar ZB4 BZ009:  $\pm 2^\circ 30'$  (excluding cut-outs marked a and b).
- Tightening torque of screws ZBZ 006: 0.6 N.m (5.3 lbf.in) max.
- Allow for one ZB4 BZ079 fixing collar/pillar and its fixing screws:
  - every 90 mm / 3.54 in. horizontally (X), and 120 mm / 4.72 in. vertically (Y).
  - with each selector switch head (ZB4 BD•, ZB4 BJ•, ZB4 BG•).

The fixing centers marked a and b are diagonally opposed and must align with those marked 4 and 5.



(1) Panel

(2) Printed circuit board

### Mounting of Adapter (Socket) ZBZ 01•

- 1 2 elongated holes for ZBZ 006 screw access
- 2 1 hole  $\varnothing 2.4 \text{ mm} \pm 0.05 / 0.09 \text{ in.} \pm 0.002$  for centring adapter ZBZ 01•
- 3 8  $\times \varnothing 1.2 \text{ mm} / 0.05 \text{ in.}$  holes
- 4 1 hole  $\varnothing 2.9 \text{ mm} \pm 0.05 / 0.11 \text{ in.} \pm 0.002$ , for aligning the printed circuit board (with cut-out marked a)
- 5 1 elongated hole for aligning the printed circuit board (with cut-out marked b)
- 6 4 holes  $\varnothing 2.4 \text{ mm} / 0.09 \text{ in.}$  for clipping in adapter ZBZ 01•

Dimensions An + 18.1 relate to the  $\varnothing 2.4 \text{ mm} \pm 0.05 / 0.09 \text{ in.} \pm 0.002$  holes for centring adapter ZBZ 01•.

---

Electrical Composition Corresponding to Code M3

---



---

Electrical Composition Corresponding to Code M4

---

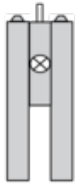

---

Electrical Composition Corresponding to Codes M6 and P2

---



---

Electrical Composition Corresponding to Codes M5, M10, MF1, MR1 and MF2

---

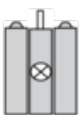

---

Legend

---

Single contact

Double contact

Light block

Possible location



### Sequence of Contacts Fitted to 3-position Selector Switch Body

#### Position 315°



Push	Position	Top			
Bottom					
Location		Left	Right		
State		1	0		
Contacts	N/O		closed	open	
N/C		open	closed		

#### Position 0°







Push	Position	Top			
Bottom					
Location		Left	Right		
State		0	0		
Contacts	N/O		open	open	
N/C		closed	closed		



Position 45°



Push	Position	Top			
Bottom					
Location		Left	Right		
State		0	1		
Contacts	N/O		open	closed	
N/C		closed	open		