



Teknisk informasjon

Produktspekter	Harmony XB4
Produkt eller type komponent	Hode for lysvendere
Produktkompatibilitet	Universal LED
Kortnavn utstyr	ZB4
Innfatningsmateriale	Forkrommet metall
Hode type	Standard
Montasjediameter	22 mm
Salg per udelelig kvantitet	1
Formen på varslingsenhetens hode	Rund
Type arm/stempel	Høyre til senter fjærretur
Operatørprofil	Blå standard grep
Informasjon om knappens stilling	3 posisjoner +/- 45°

Komplementær

Bredde	29 mm
Høyde	29 mm
Dybde	43 mm
Vekt	0,036 kg
Resistens til høytrykksvask	7000000 Pa på 55 °C, distanse : 0.1 m
Mekanisk levetid	500000 sykluser
Elektrisk sammensetningskode	M3 for <4 kontakter bruker Enkel blokker i frontmontering med innebygget LED M6 for <2 kontakter bruker Enkel blokker i frontmontering med integrert LED og transformator M10 for <2 kontakter bruker Enkel blokker i frontmontering med innebygget LED M4 for <4 kontakter bruker enkel og dobbel blokker i frontmontering med innebygget LED
Enhetens utseende	Basic element

Miljø

Overflatebeskyttelse	TH
Omgivelsestemperatur for lagring	-40...70 °C
Omgivelsestemperatur drift	-40...70 °C
Overspenningskategori	Klasse I i samsvar med IEC 60536
IP-grad	IP66 i samsvar med IEC 60529 IP67 IP69 IP69K
NEMA beskyttelsesgrad	NEMA 13 NEMA 4X
IK beskyttelsesklasse	IK06 i samsvar med IEC 50102
Standarder	EN/IEC 60947-5-5 UL 508 JIS C8201-5-1 EN/IEC 60947-1 EN/IEC 60947-5-4 EN/IEC 60947-5-1 CSA C22.2 No 14 JIS C8201-1

Produktsertifikater	LROS (Lloyds register of shipping) UL listet DNV CSA BV GL
Vibrasjonsmotstand	5 gn ($f = 2 \dots 500$ Hz) i samsvar med IEC 60068-2-6
Støtmotstand	30 gn (varighet = 18 ms) for halvsinusurve akselerasjon i samsvar med IEC 60068-2-27 50 gn (varighet = 11 ms) for halvsinusurve akselerasjon i samsvar med IEC 60068-2-27

Forpakkingsinformasjon

Enhetstype pakke 1	PCE
Antall enheter i pakke 1	1
Pakke 1 Høyde	8,8 cm
Pakke 1 Bredde	3,4 cm
Pakke 1 Vekt	5,4 cm
Package 1 Weight	80 g
Enhetstype pakke 2	BB1
Antall enheter i pakke 2	10
Pakke 2 Høyde	7 cm
Pakke 2 Bredde	26,5 cm
Pakke 2 Lengde	100 cm
Pakke 2 Vekt	800 g
Enhetstype pakke 3	S01
Antall enheter i pakke 3	50
Pakke 3 Høyde	15 cm
Pakke 3 Bredde	15 cm
Pakke 3 Lengde	40 cm
Pakke 3 Vekt	2,275 kg

Bærekraftig

Produktets miljøstatus	Green Premium miljømerket produkt
REACH-regelverk	REACH-erklæring
REACH fri for SVHC	Ja
EU RoHS-direktiv	Proaktivt i samsvar (Produktet inngår ikke i EUs RoHS direktivet) EU RoHS-erklæring
Fri for giftige tungmetaller	Ja
Kvikksølvfri	Ja
Kinas RoHS-forskrift	Kinas RoHS-Erklæring
Informasjon om RoHS-unntak	Ja
Miljøinformasjon	Produktmiljøprofil
Produktets livssyklus	Informasjon Om Levetidsslutt

Garantiperiode

Garanti	18 months
---------	-----------

Dimensions

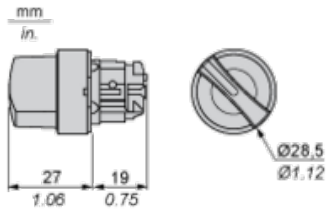

Panel Cut-out for Pushbuttons, Switches and Pilot Lights (Finished Holes, Ready for Installation)

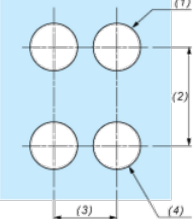
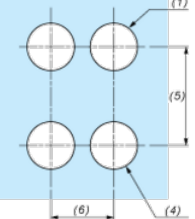
Connection by Screw Clamp Terminals or Plug-in Connectors or on Printed Circuit Board	Connection by Faston Connectors
	
<p>(1) Diameter on finished panel or support (2) 40 mm min. / 1.57 in. min. (3) 30 mm min. / 1.18 in. min. (4) $\varnothing 22.5$ mm / 0.89 in. recommended ($\varnothing 22.3$ mm $_0^{+0.4}$ / 0.88 in. $_0^{+0.016}$) (5) 45 mm min. / 1.78 in. min. (6) 32 mm min. / 1.26 in. min.</p>	

Pushbuttons, Switches and Pilot Lights for Printed Circuit Board Connection

Panel Cut-outs (Viewed from Installer's Side)

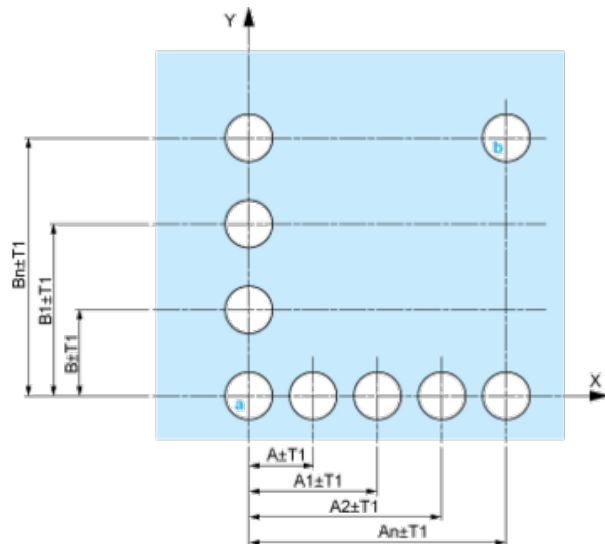

A: 30 mm min. / 1.18 in. min.
 B: 40 mm min. / 1.57 in. min.

Printed Circuit Board Cut-outs (Viewed from Electrical Block Side)

Dimensions in mm



A: 30 mm min.
 B: 40 mm min.
 Dimensions in in.



A: 1.18 in. min.
 B: 1.57 in. min.

General Tolerances of the Panel and Printed Circuit Board

The cumulative tolerance must not exceed 0.3 mm / 0.012 in: $T_1 + T_2 = 0.3 \text{ mm max.}$

Installation Precautions

- Minimum thickness of circuit board: 1.6 mm / 0.06 in.
- Cut-out diameter: 22.4 mm \pm 0.1 / 0.88 in. \pm 0.004
- Orientation of body/fixing collar ZB4 BZ009: $\pm 2^\circ 30'$ (excluding cut-outs marked a and b).
- Tightening torque of screws ZBZ 006: 0.6 N.m (5.3 lbf.in) max.
- Allow for one ZB4 BZ079 fixing collar/pillar and its fixing screws:
 - every 90 mm / 3.54 in. horizontally (X), and 120 mm / 4.72 in. vertically (Y).
 - with each selector switch head (ZB4 BD•, ZB4 BJ•, ZB4 BG•).

The fixing centers marked a and b are diagonally opposed and must align with those marked 4 and 5.



(1) Panel

(2) Printed circuit board

Mounting of Adapter (Socket) ZBZ 01*

- 1 2 elongated holes for ZBZ 006 screw access
- 2 1 hole \varnothing 2.4 mm \pm 0.05 / 0.09 in. \pm 0.002 for centring adapter ZBZ 01*
- 3 8 \times \varnothing 1.2 mm / 0.05 in. holes
- 4 1 hole \varnothing 2.9 mm \pm 0.05 / 0.11 in. \pm 0.002, for aligning the printed circuit board (with cut-out marked a)
- 5 1 elongated hole for aligning the printed circuit board (with cut-out marked b)
- 6 4 holes \varnothing 2.4 mm / 0.09 in. for clipping in adapter ZBZ 01*

Dimensions An + 18.1 relate to the \varnothing 2.4 mm \pm 0.05 / 0.09 in. \pm 0.002 holes for centring adapter ZBZ 01*.

Electrical Composition Corresponding to Code M3



Electrical Composition Corresponding to Code M4

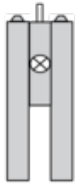

Electrical Composition Corresponding to Codes M6 and P2



Electrical Composition Corresponding to Codes M5, M10, MF1, MR1 and MF2

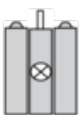

Legend

Single contact

Double contact

Light block

Possible location



Sequence of Contacts Fitted to 3-position Selector Switch Body

Position 315°



Push	Position	Top			
Bottom					
Location		Left	Right		
State		1	0		
Contacts	N/O		closed	open	
N/C		open	closed		





Position 0°



Push	Position	Top			
Bottom					
Location		Left	Right		
State		0	0		
Contacts	N/O		open	open	
N/C		closed	closed		

Position 45°



Push	Position	Top			
Bottom					
Location		Left	Right		
State		0	1		
Contacts	N/O		open	closed	
N/C		closed	open		