



### Teknisk informasjon

Produktspekter	Harmony XB5
Produkt eller type komponent	Hode for lysvendere
Produktkompatibilitet	Universal LED
Kortnavn utstyr	ZB5
Innfaningsmateriale	Dark grey plastic
Montasjediameter	22 mm
Hode type	Standard
Salg per udelelig kvantitet	1
Formen på varslingsenhetens hode	Rund
Type arm/stempel	fast
Operatørprofil	Rød standard grep
Informasjon om knappens stilling	2 posisjoner 90°

### Komplementær

Bredde	29 mm
Høyde	29 mm
Dybde	43 mm
Vekt	0,016 kg
Mekanisk levetid	1000000 sykluser
Stasjonsnavn	XALD 1...5 hull XALK 2...5 hull
Elektrisk sammensetningskode	M3 for <4 kontakter bruker Enkel blokker i frontmontering med innebygget LED M6 for <2 kontakter bruker Enkel blokker i frontmontering med integrert LED og transformator M10 for <2 kontakter bruker Enkel blokker i frontmontering med innebygget LED MF1 for <2 kontakter bruker Enkel blokker i frontmontering med innebygget LED MR1 for <2 kontakter bruker Enkel blokker i bakmontering med innebygget LED M4 for <4 kontakter bruker enkel og dobbel blokker i frontmontering med innebygget LED
Enhetens utseende	Basic element

### Miljø

Overflatebeskyttelse	TH
Omgivelsestemperatur for lagring	-40...70 °C
Omgivelsestemperatur drift	-40...70 °C
Overspenningskategori	Klasse II i samsvar med IEC 60536
IP-grad	IP66 i samsvar med IEC 60529 IP67 IP69 IP69K
NEMA beskyttelsesgrad	NEMA 13 NEMA 4X
Resistens til høytrykksvask	7000000 Pa på 55 °C, distanse : 0.1 m
IK beskyttelsesklasse	IK06 i samsvar med IEC 50102

Standarder	EN/IEC 60947-5-5 UL 508 EN/IEC 60947-5-4 EN/IEC 60947-1 CSA C22.2 No 14 JIS C8201-5-1 EN/IEC 60947-5-1 JIS C8201-1
Produktsertifikater	GL LROS (Lloyds register of shipping) UL listet BV DNV CSA
Vibrasjonsmotstand	5 gn (f= 2...500 Hz) i samsvar med IEC 60068-2-6
Støtmotstand	30 gn (varighet = 18 ms) for halv sinuskurve akselerasjon i samsvar med IEC 60068-2-27 50 gn (varighet = 11 ms) for halv sinuskurve akselerasjon i samsvar med IEC 60068-2-27

## Forpakkingsinformasjon

Enhetstype pakke 1	PCE
Antall enheter i pakke 1	1
Pakke 1 Høyde	3,3 cm
Pakke 1 Bredde	5,2 cm
Pakke 1 Vekt	5,5 cm
Package 1 Weight	24 g
Enhetstype pakke 2	S02
Antall enheter i pakke 2	100
Pakke 2 Høyde	15 cm
Pakke 2 Bredde	30 cm
Pakke 2 Lengde	40 cm
Pakke 2 Vekt	2,707 kg

## Bærekraftig

Produktets miljøstatus	Green Premium miljømerket produkt
REACH-regelverk	<a href="#">REACH-erklæring</a>
REACH fri for SVHC	Ja
EU RoHS-direktiv	Proaktivt i samsvar (Produktet inngår ikke i EUs RoHS direktivet) <a href="#">EU RoHS-erklæring</a>
Fri for giftige tungmetaller	Ja
Kvikksølvfri	Ja
Kinas RoHS-forskrift	<a href="#">Kinas RoHS-Erklæring</a>
Informasjon om RoHS-unntak	<a href="#">Ja</a>
Miljøinformasjon	<a href="#">Produktmiljøprofil</a>
Produktets livssyklus	<a href="#">Informasjon Om Levetidsslutt</a>

## Garantiperiode

Garanti	18 months
---------	-----------

---

Dimensions

---

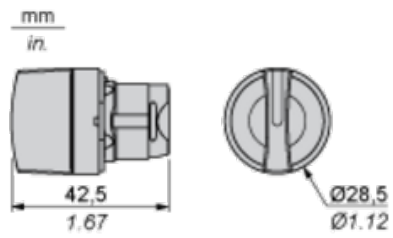

Panel Cut-out for Pushbuttons, Switches and Pilot Lights (Finished Holes, Ready for Installation)

Connection by Screw Clamp Terminals or Plug-in Connectors or on Printed Circuit Board

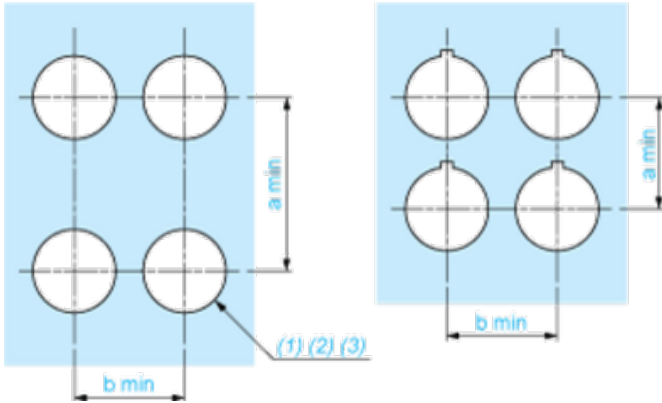

- (1) Diameter on finished panel or support
- (2) For selector switches and Emergency stop buttons, use of an anti-rotation plate type ZB5AZ902 is recommended.
- (3)  $\varnothing 22.5$  mm recommended ( $\varnothing 22.3_0^{+0.4}$ ) /  $\varnothing 0.89$  in. recommended ( $\varnothing 0.88$  in.  $_0^{+0.016}$ )

Connections	a in mm	a in in.	b in mm	b in in.
By screw clamp terminals or plug-in connector	40	1.57	30	1.18
By Faston connectors	45	1.77	32	1.26
On printed circuit board	30	1.18	30	1.18

Detail of Lug Recess

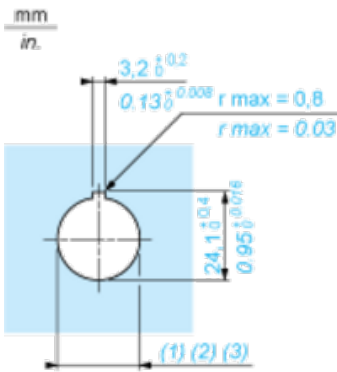

- (1) Diameter on finished panel or support
- (2) For selector switches and Emergency stop buttons, use of an anti-rotation plate type ZB5AZ902 is recommended.
- (3)  $\varnothing 22.5$  mm recommended ( $\varnothing 22.3_0^{+0.4}$ ) /  $\varnothing 0.89$  in. recommended ( $\varnothing 0.88$  in.  $_0^{+0.016}$ )

Pushbuttons, Switches and Pilot Lights for Printed Circuit Board Connection

Panel Cut-outs (Viewed from Installer's Side)



A: 30 mm min. / 1.18 in. min.

B: 40 mm min. / 1.57 in. min.

Printed Circuit Board Cut-outs (Viewed from Electrical Block Side)

Dimensions in mm



A: 30 mm min.

B: 40 mm min.

Dimensions in in.



A: 1.18 in. min.  
 B: 1.57 in. min.

### General Tolerances of the Panel and Printed Circuit Board

The cumulative tolerance must not exceed 0.3 mm / 0.012 in.: T1 + T2 = 0.3 mm max.

### Installation Precautions

- Minimum thickness of circuit board: 1.6 mm / 0.06 in.
- Cut-out diameter: 22.4 mm ± 0.1 / 0.88 in. ± 0.004
- Orientation of body/fixing collar ZB5AZ009: ± 2° 30' (excluding cut-outs marked a and b).
- Tightening torque of screws ZBZ006: 0.6 N.m (5.3 lbf.in) max.
- Allow for one ZB5AZ079 fixing collar/pillar and its fixing screws:
  - every 90 mm / 3.54 in. horizontally (X), and 120 mm / 4.72 in. vertically (Y).
  - with each selector switch head (ZB5AD•, ZB5AJ•, ZB5AG•).

The fixing centers marked a and b are diagonally opposed and must align with those marked 4 and 5.

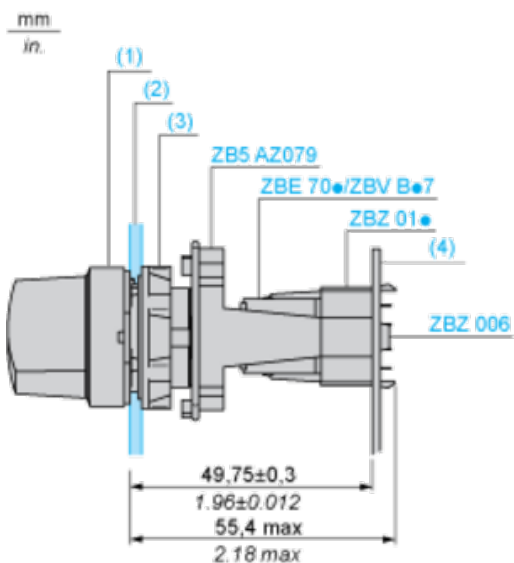

- (1) Head ZB5AD•  
 (2) Panel  
 (2) Nut

#### (4) Printed circuit board

##### Mounting of Adapter (Socket) ZBZ01•

- 1 2 elongated holes for ZBZ006 screw access
- 2 1 hole  $\varnothing$  2.4 mm  $\pm$  0.05 / 0.09 in.  $\pm$  0.002 for centring adapter ZBZ01•
- 3 8  $\times$   $\varnothing$  1.2 mm / 0.05 in. holes
- 4 1 hole  $\varnothing$  2.9 mm  $\pm$  0.05 / 0.11 in.  $\pm$  0.002, for aligning the printed circuit board (with cut-out marked a)
- 5 1 elongated hole for aligning the printed circuit board (with cut-out marked b)
- 6 4 holes  $\varnothing$  2.4 mm / 0.09 in. for clipping in adapter ZBZ01•

Dimensions An + 18.1 relate to the  $\varnothing$  2.4 mm  $\pm$  0.05 / 0.09 in.  $\pm$  0.002 holes for centring adapter ZBZ01•.

---

Electrical Composition Corresponding to Code M3

---

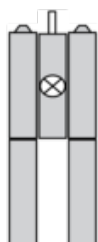

---

Electrical Composition Corresponding to Code M4

---

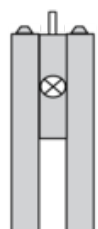

---

Electrical Composition Corresponding to Codes M6 and P2

---

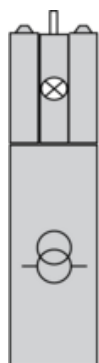

---

Electrical Composition Corresponding to Codes M5, M10, MF1, MR1 and MF2

---

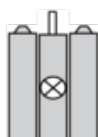

---

Legend

---

Single contact



Double contact

Light block





Possible location



### Sequence of Contacts Fitted to 2-position Selector Switch Body

#### Position 315°



Push	Position	Top			
Bottom					
Location		Left	Right		
State		0	0		
Contacts	N/O		open	open	
N/C		closed	closed		

#### Position 45°



Push	Position	Top			
Bottom	<input type="checkbox"/>	<input type="checkbox"/>			
Location		Left	Right		
State		1	1		
Contacts	N/O		closed	closed	
N/C		open	open		