



Teknisk informasjon

Produktspekter	Modicon ABE7
Produkt eller type komponent	Sub-base with plug-in electromechanical relay
Sub-base type	Output sub-base
[Us] merkespenning	19 - 30 V i samsvar med IEC 61131-2
Antall kanaler	16

Komplementær

Supply voltage type	DC
Produktkompatibilitet	ABR7S37
Status LED	1 LED per kanal (grønn) kanalstatus 1 LED (grønn) POWER ON
Polaritetsfordeling	Spenningsløs
Kortslutningsvern	1 A internal fuse, 5 x 20 mm, fast blow (PLC sluttet)
Festemetode	Med klips (35 mm symmetrical DIN rail) Med skruer (solid plate with fixing kit)
Maks forsyningsstrøm	1 A
Spenningsfall på strømforsyningen sikring	0,3 V
[Ui] isolasjonsspenning	2000 V terminaler / monteringskinnene 300 V spiral krets / kontaktkretser i samsvar med IEC 60947-1
[Uimp] Nominell impuls spenning	2,5 kV
Installasjonskategori	II i samsvar med IEC 60664-1
Tiltrekningsmoment	0,6 N.m med flat Ø 3,5 mm skrutrekker
Vekt	1,3 kg

Miljø

Produktsertifikater	DNV LROS (Lloyds register of shipping) BV CSA GL EAC
IP-grad	IP2x i samsvar med IEC 60529
Glødetrådtype	750 °C i samsvar med IEC 60695-2-11
Støtmotstand	15 gn for 11 ms i samsvar med IEC 60068-2-27
Vibrasjonsmotstand	2 gn (f= 10...150 Hz) i samsvar med IEC 60068-2-6
Motstand mot elektrostatisk utladning	4 kV (kontakt) nivå 3 i samsvar med IEC 61000-4-2 8 kV (luft) nivå 3 i samsvar med IEC 61000-4-2
Motstand mot utstrålende felter	10 V/m (26000000...1000000000 Hz) i samsvar med IEC 61000-4-3 nivå 3
Motstand mot raske transienter	2 kV nivå 3 i samsvar med IEC 61000-4-4
Omgivelsestemperatur for drift	-5...60 °C i samsvar med IEC 61131-2
Omgivende lufttemperatur for oppbevaring	-40...80 °C i samsvar med IEC 61131-2
Forurensningsgrad	2 i samsvar med IEC 60664-1

Forpakkingsinformasjon

Enhetstype forpakning 1	PCE
Antall enheter forpakning 1	1
Forpakning 1 vekt	1,181 kg
Forpakning 1 høyde	8,5 cm
Forpakning 1 bredde	10,0 cm
Forpakning 1 lengde	29,2 cm
Enhetstype forpakning 2	S03
Antall enheter forpakning 2	6
Forpakning 2 vekt	7,557 kg
Forpakning 2 høyde	30,0 cm
Forpakning 2 bredde	30,0 cm
Forpakning 2 lengde	40,0 cm

Bærekraftig

Produktets miljøstatus	Green Premium miljømerket produkt
REACH-regelverk	REACH-erklæring
REACH fri for SVHC	Ja
EU RoHS-direktiv	Proaktivt i samsvar (Produktet inngår ikke i EUs RoHS direktivet) EU RoHS-erklæring
Kvikksølvfri	Ja
Informasjon om RoHS-unntak	Ja
Kinas RoHS-forskrift	Kinas RoHS-Erklæring
Miljøinformasjon	Produktmiljøprofil
Produktets livssyklus	Informasjon Om Levetidsslutt
WEEE	Innen EU må produktet avhendes i henhold til bestemte regler for avfallshåndtering og aldri kastes som husholdningsavfall.

Garantiperiode

Garanti	18 months
---------	-----------

Dimensions

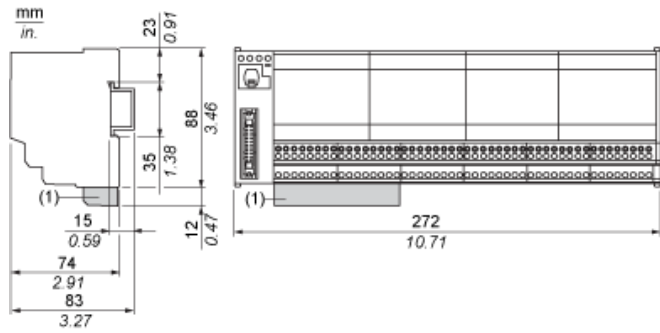

(1) ABE7BV10 / BV20, ABE7BV10E / BV20E

Mounting

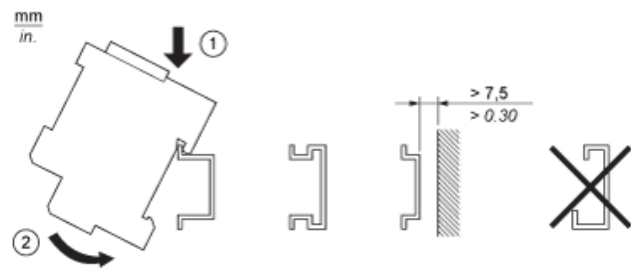

HE10 16 Channels

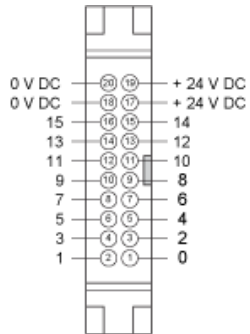

Wiring Diagram with Other Relays not Supplied

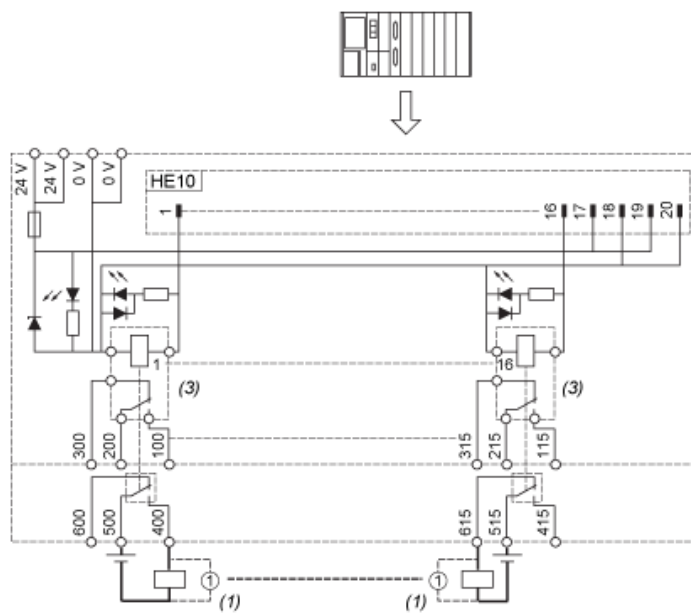

- (1) Inductive load
- (3) ABR7S37 (2 "OF" "DPDT") Ith = 8 A (supplied)

Curves for Determining Cable Type and Length According to the Current

16-channel Sub-base

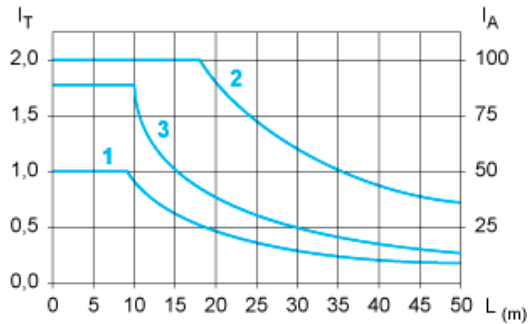

- L Cable length
- I_T Total current per sub base (A)
- I_A Average current per channel (mA)
- (1) TSXC DP••2 and ABFH20H••0 cables with c.s.a. 0.08 mm² (AWG 28).
- (2) TSXC DP••3 cables with c.s.a. 0.34 mm² (AWG 22).
- (3) Cables with c.s.a. 0.13 mm² (AWG 26).

The curves are given for a voltage drop of 1 V in the cable. For n volts tolerance, multiply the length determined from the graph by n.

Temperature Derating Curves

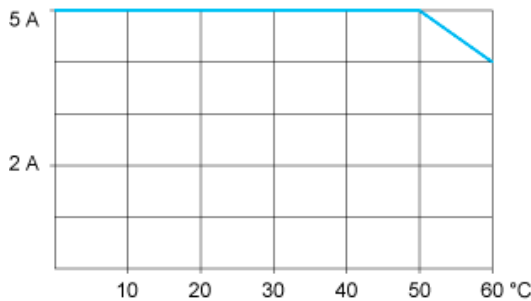

Electrical Durability (in Millions of Operating Cycles) Conforming to IEC 60947-5-1

DC Loads

DC12 curves

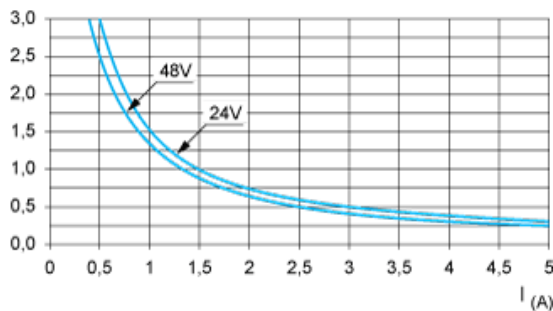

DC12control of resistive loads and of solid state loads isolated by optocoupler, I/R ≤ 1 ms.

DC13 curves

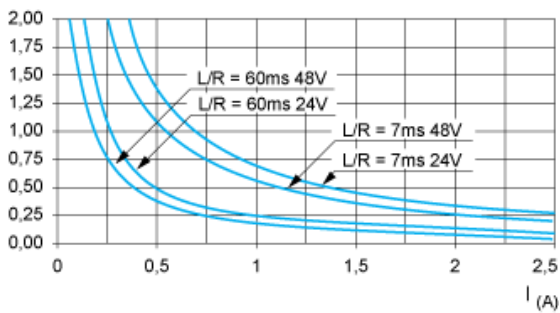

DC13 Switching electromagnets, $L/R \leq 2 \times (U_e \times I_e)$ in ms, U_e : rated operational voltage, I_e : rated operational current (with a protective diode on the load, DC12 curves must be used with a coefficient of 0.9 applied to the number in millions of operating cycles)

AC Loads

AC12 curves

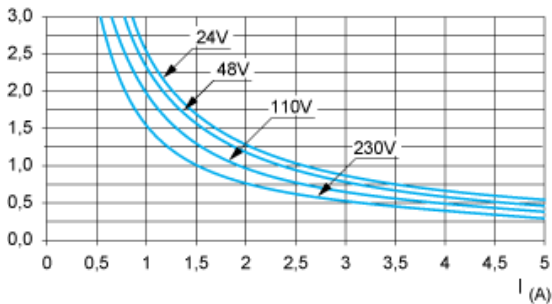

AC12 control of resistive loads and of solid state loads isolated by optocoupler, $\cos \phi \geq 0.9$.

AC14 curves

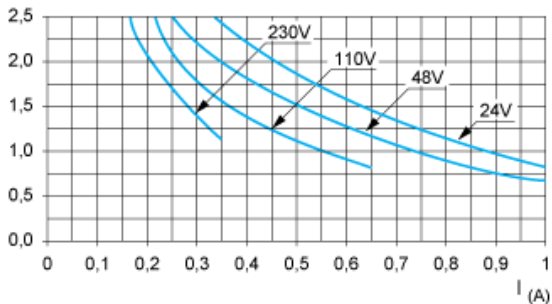

AC14 control of small electromagnetic loads ≤ 72 VA, make: $\cos \phi = 0.3$, break: $\cos \phi = 0.3$.

AC15 curves

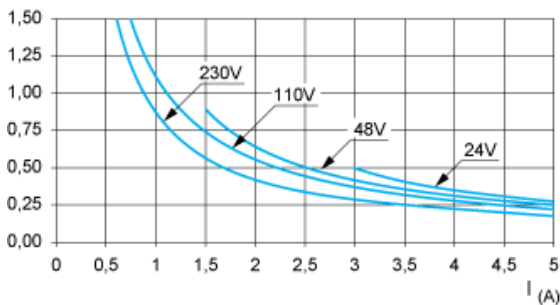

AC15 control of electromagnetic loads > 72 VA, make: $\cos \phi = 0.7$, break: $\cos \phi = 0.4$.