

Produktdata

Produktområde	Harmony XB5
Typ av produkt eller komponent	Lampvred
Produktkompatibilitet	Universal LED
Enhetens korta namn	ZB5
Material frontring	Mörkgrå plast
Montagediameter	22 mm
Typ av huvud	Standard
Försäljning per odelbar kvantitet	1
Form på signalenhetens huvud	Rund
Typ av manöverdon	Återfjädring höger till mitten
Manöverdon profil	Standardhandtag röd
Information om manöverposition	3 lägen +/- 45°

Teknisk data

Bredd	29 mm
Höjd	29 mm
Djup	43 mm
Produktens vikt	0,016 kg
Mekanisk livslängd	1000000 cycles
Stationsnamn	XALD 1...5 hål XALK 2...5 hål
Elektrisk sammansättningskod	M3 för <4 kontakter använder singel block i frontmontage med inbyggd LED M6 för <2 kontakter använder singel block i frontmontage med inbyggd LED och transformator M10 för <2 kontakter använder singel block i frontmontage med inbyggd LED MF1 för <2 kontakter använder singel block i frontmontage med inbyggd LED MR1 för <2 kontakter använder singel block i bakre montering med inbyggd LED M4 för <4 kontakter använder singel och dubbel block i frontmontage med inbyggd LED
Produktbeskrivning	Produkt i alla delar

Miljö

Skyddsbehandling	TH
Omgivande lufttemperatur för lagring	-40...70 °C
Omgivningstemperatur vid drift	-40...70 °C
Överspänningskategori	Klass II överensstämmer med IEC 60536
IP-kapslingsklass	IP66 överensstämmer med IEC 60529 IP67 IP69 IP69K
NEMA kapslingsklass	NEMA 13 NEMA 4X
Motstånd mot högtryckstvätt	7000000 Pa vid 55 °C, distans : 0.1 m
IK-skyddsgrad	IK06 överensstämmer med IEC 50102

Standarder	EN/IEC 60947-5-1 EN/IEC 60947-1 UL 508 CSA C22.2 EN/IEC 60947-5-4 JIS C8201-5-1 EN/IEC 60947-5-5 JIS C8201-1
Produktcertifieringar	BV LROS (Lloyds register of shipping) CSA GL UL listad DNV
Vibrationsbeständighet	5 gn (f= 2...500 Hz) överensstämmer med IEC 60068-2-6
Chocktålighet	30 gn (varaktighet = 18 ms) för halv sinusacceleration överensstämmer med IEC 60068-2-27 50 gn (varaktighet = 11 ms) för halv sinusacceleration överensstämmer med IEC 60068-2-27

Förpackningsinformation

Förpackningstyp 1	PCE
Antal i Förpackning 1	1
Förpackning 1 höjd	5,6 cm
Förpackning 1 bredd	3,4 cm
Förpackning 1 djup	5,4 cm
Förpackning 1 vikt	21,0 g
Förpackningstyp 2	S02
Antal i Förpackning 2	100
Förpackning 2 höjd	15,0 cm
Förpackning 2 bredd	30,0 cm
Förpackning 2 djup	40,0 cm
Förpackning 2 vikt	2,655 kg

Hållbarhetsinformation

Hållbarhetsstatus	Green Premium-produkt
REACH-förordning	REACH-Deklaration
Innehåller ej REACH SVHC-ämnen	Ja
EU RoHS-direktiv	Proaktiv överensstämmelse (produkten utanför EU RoHS juridiska omfattning) EU RoHS-deklaration
Innehåller ej giftiga tungmetaller	Ja
Kvicksilverfri	Ja
RoHS-undantagsinformation	Ja
RoHS-förordning Kina	RoHS-deklaration Kina
Miljöupplysning	Produktmiljöprofil
Cirkulationsprofil	Information Om Livslängdsslut

Kontraktsgaranti

Garanti	18 months
---------	-----------

Dimensions

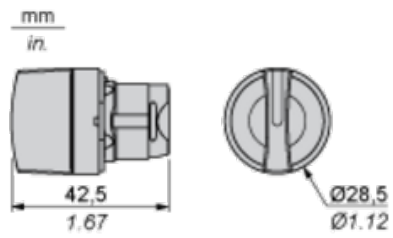

Panel Cut-out for Pushbuttons, Switches and Pilot Lights (Finished Holes, Ready for Installation)

Connection by Screw Clamp Terminals or Plug-in Connectors or on Printed Circuit Board

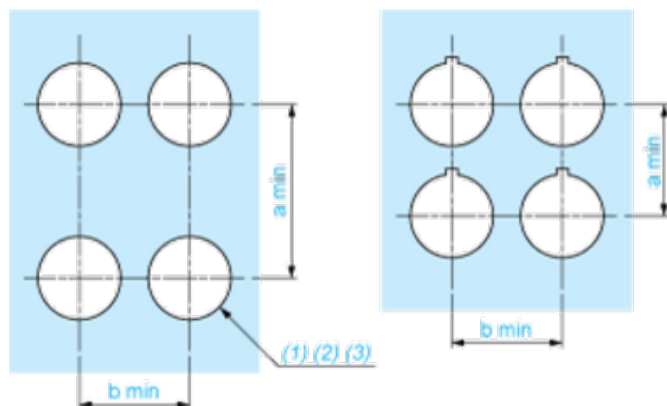

- (1) Diameter on finished panel or support
- (2) For selector switches and Emergency stop buttons, use of an anti-rotation plate type ZB5AZ902 is recommended.
- (3) $\varnothing 22.5$ mm recommended ($\varnothing 22.3_0^{+0.4}$) / $\varnothing 0.89$ in. recommended ($\varnothing 0.88$ in. $_0^{+0.016}$)

Connections	a in mm	a in in.	b in mm	b in in.
By screw clamp terminals or plug-in connector	40	1.57	30	1.18
By Faston connectors	45	1.77	32	1.26
On printed circuit board	30	1.18	30	1.18

Detail of Lug Recess



- (1) Diameter on finished panel or support
- (2) For selector switches and Emergency stop buttons, use of an anti-rotation plate type ZB5AZ902 is recommended.
- (3) $\varnothing 22.5$ mm recommended ($\varnothing 22.3_0^{+0.4}$) / $\varnothing 0.89$ in. recommended ($\varnothing 0.88$ in. $_0^{+0.016}$)

Pushbuttons, Switches and Pilot Lights for Printed Circuit Board Connection

Panel Cut-outs (Viewed from Installer's Side)

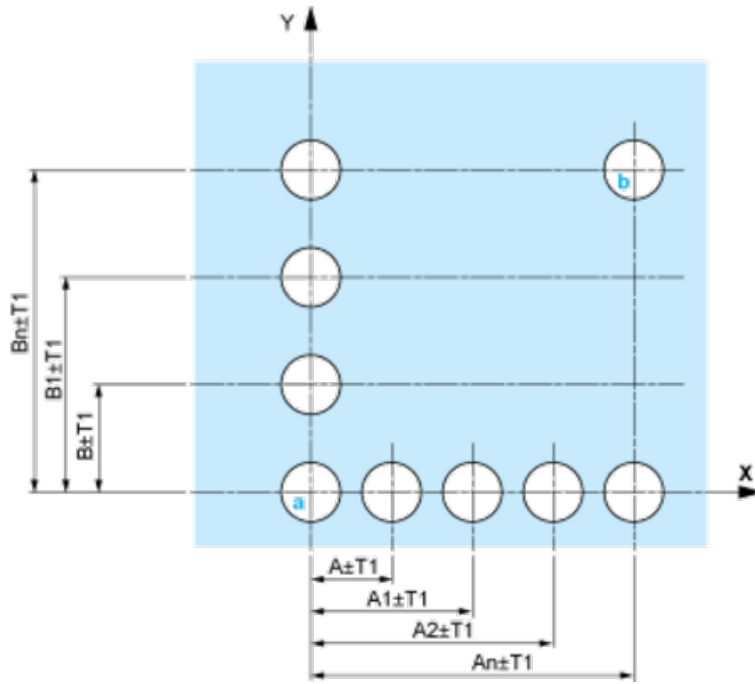

A: 30 mm min. / 1.18 in. min.

B: 40 mm min. / 1.57 in. min.

Printed Circuit Board Cut-outs (Viewed from Electrical Block Side)

Dimensions in mm

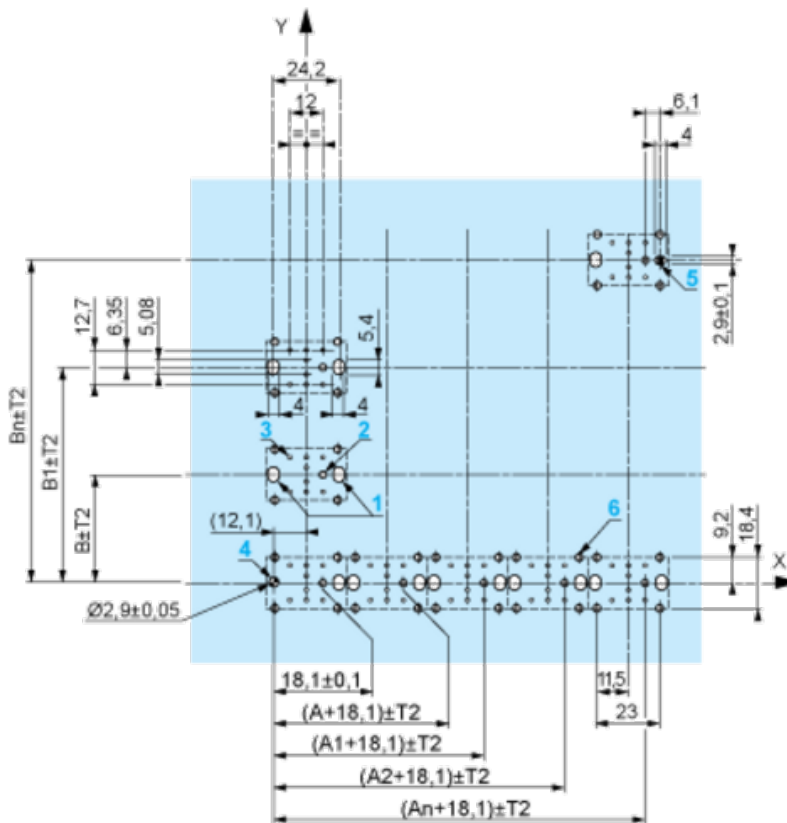

A: 30 mm min.

B: 40 mm min.

Dimensions in in.

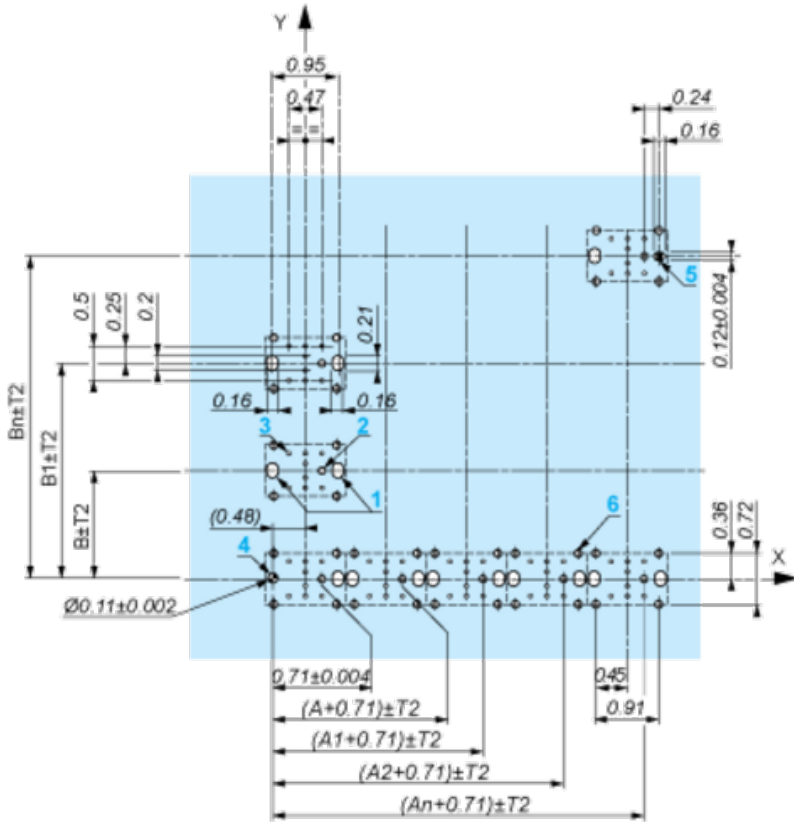

A: 1.18 in. min.
 B: 1.57 in. min.

General Tolerances of the Panel and Printed Circuit Board

The cumulative tolerance must not exceed 0.3 mm / 0.012 in.: $T1 + T2 = 0.3 \text{ mm max.}$

Installation Precautions

- Minimum thickness of circuit board: 1.6 mm / 0.06 in.
- Cut-out diameter: 22.4 mm \pm 0.1 / 0.88 in. \pm 0.004
- Orientation of body/fixing collar ZB5AZ009: $\pm 2^\circ 30'$ (excluding cut-outs marked a and b).
- Tightening torque of screws ZBZ006: 0.6 N.m (5.3 lbf.in) max.
- Allow for one ZB5AZ079 fixing collar/pillar and its fixing screws:
 - every 90 mm / 3.54 in. horizontally (X), and 120 mm / 4.72 in. vertically (Y).
 - with each selector switch head (ZB5AD*, ZB5AJ*, ZB5AG*).

The fixing centers marked a and b are diagonally opposed and must align with those marked 4 and 5.

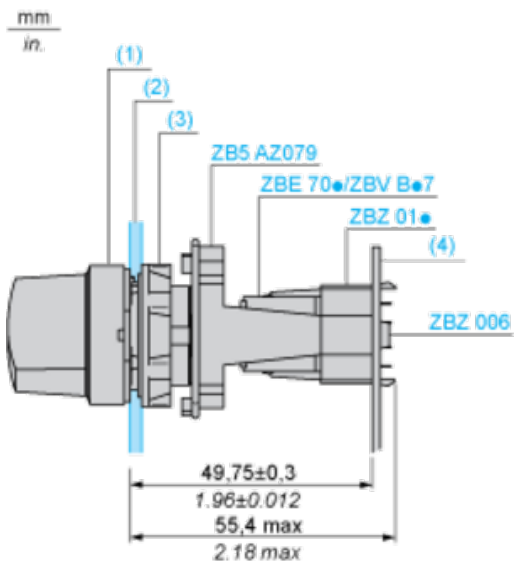

- (1) Head ZB5AD*
 (2) Panel
 (2) Nut

(4) Printed circuit board

Mounting of Adapter (Socket) ZBZ01•

- 1 2 elongated holes for ZBZ006 screw access
- 2 1 hole \varnothing 2.4 mm \pm 0.05 / 0.09 in. \pm 0.002 for centring adapter ZBZ01•
- 3 8 \times \varnothing 1.2 mm / 0.05 in. holes
- 4 1 hole \varnothing 2.9 mm \pm 0.05 / 0.11 in. \pm 0.002, for aligning the printed circuit board (with cut-out marked a)
- 5 1 elongated hole for aligning the printed circuit board (with cut-out marked b)
- 6 4 holes \varnothing 2.4 mm / 0.09 in. for clipping in adapter ZBZ01•

Dimensions An + 18.1 relate to the \varnothing 2.4 mm \pm 0.05 / 0.09 in. \pm 0.002 holes for centring adapter ZBZ01•.

Electrical Composition Corresponding to Code M3

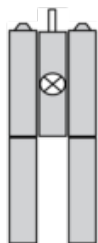

Electrical Composition Corresponding to Code M4

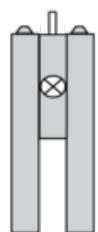

Electrical Composition Corresponding to Codes M6 and P2

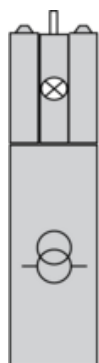

Electrical Composition Corresponding to Codes M5, M10, MF1, MR1 and MF2

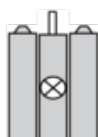

Legend

Single contact

Double contact

Light block





Possible location



Sequence of Contacts Fitted to 3-position Selector Switch Body

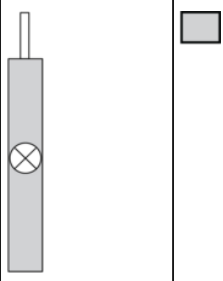



Position 315°



Push	Position	Top			
Bottom					
Location		Left	Right		
State		1	0		
Contacts	N/O		closed	open	
N/C		open	closed		





Position 0°



Push	Position	Top			
Bottom					
Location		Left	Right		
State		0	0		
Contacts	N/O		open	open	
N/C		closed	closed		

Position 45°



Push	Position	Top			
Bottom					
Location		Left	Right		
State		0	1		
Contacts	N/O		open	closed	
N/C		closed	open		