



Main

Range of product	TeSys GV4
Range	TeSys Deca TeSys Deca
Device short name	GV4L
Product name	TeSys GV4 TeSys Deca
Product or component type	Motor circuit breaker
Device application	Motor protection
Trip unit technology	Magnetic Electronic

Complementary

Poles description	3P
Utilisation category	Category A conforming to IEC 60947-2 AC-3 conforming to IEC 60947-4-1
Operating position	Any position
Motor power kW	37 kW at 400...415 V AC 50/60 Hz 45 kW at 400...415 V AC 50/60 Hz 55 kW at 400...415 V AC 50/60 Hz 45 kW at 500 V AC 50/60 Hz 55 kW at 500 V AC 50/60 Hz 75 kW at 500 V AC 50/60 Hz 75 kW at 660...690 V AC 50/60 Hz 90 kW at 660...690 V AC 50/60 Hz 110 kW at 660...690 V AC 50/60 Hz
Breaking capacity	50 kA Icu at 220...240 V AC 50/60 Hz conforming to IEC 60947-2 25 kA Icu at 380...415 V AC 50/60 Hz conforming to IEC 60947-2 20 kA Icu at 440 V AC 50/60 Hz conforming to IEC 60947-2 10 kA Icu at 500 V AC 50/60 Hz conforming to IEC 60947-2
Control type	Rotary handle
[In] rated current	115 A
Magnetic tripping current	690...1610 A
[Ue] rated operational voltage	690 V AC 50/60 Hz conforming to IEC 60947-2
[Ui] rated insulation voltage	800 V AC 50/60 Hz conforming to IEC 60947-2
[Ith] conventional free air thermal current	115 A conforming to IEC 60947-4-1
[Uimp] rated impulse withstand voltage	8 kV conforming to IEC 60947-2
Power dissipation per pole	6.1 W
Mechanical durability	40000 cycles
Electrical durability	10000 Cycles for AC-3 at 440 V In/2 5000 cycles for AC-3 at 440 V In
Maximum operating rate	25 cyc/h
Rated duty	Continuous conforming to IEC 60947-4-1
Connections - terminals	EverLink BTR screw connectors (top) 1 cable(s) 1.5...70 mm ² - solid EverLink BTR screw connectors (top) 1 cable(s) 1.5...50 mm ² - flexible EverLink BTR screw connectors (bottom) 1 cable(s) 2.5...95 mm ² - solid EverLink BTR screw connectors (bottom) 1 cable(s) 2.5...70 mm ² - flexible
Tightening torque	9 N.M for cable 16...95 mm ² 5 N.m for cable 1.5...10 mm ²
Mechanical robustness	Vibrations: +/- 1 mm 2...13.2 Hz conforming to IEC 60068-2-6 Vibrations: 0.7 gn 13.2...100 Hz conforming to IEC 60068-2-6 Shocks: 15 gn 11 ms conforming to IEC 60068-2-27

The information provided in this documentation contains general descriptions and/or technical characteristics of the performance of the products contained herein. This documentation is not intended as a substitute for and is not to be used for determining suitability or reliability of these products for specific user applications. It is the duty of any such user or integrator to perform the appropriate and complete risk analysis, evaluation and testing of the products with respect to the relevant specific application or use thereof. Neither Schneider Electric Industries SAS nor any of its affiliates or subsidiaries shall be responsible or liable for misuse of the information contained herein.

Height	155 mm
Width	81 mm
Depth	165 mm
Net weight	1.65 kg
Colour	Grey (RAL 7016)
Suitability for isolation	Yes conforming to IEC 60947-1



Environment

Standards	EN/IEC 60947-4-1 EN/IEC 60947-2
Product certifications	IEC[RETURN]CCC[RETURN]EAC[RETURN]EU-RO MR
Climatic withstand	Conforming to IACS E10
IK degree of protection	IK07 conforming to IEC 62262
Pollution degree	3
IP degree of protection	IP40 conforming to IEC 60529
Ambient air temperature for storage	-50...85 °C
Fire resistance	960 °C conforming to IEC 60695-2-11
Operating altitude	5000 m
Ambient air temperature for operation	-25...70 °C

Packing Units

Unit Type of Package 1	PCE
Number of Units in Package 1	1
Package 1 Height	10.500 cm
Package 1 Width	20.800 cm
Package 1 Length	22.000 cm
Package 1 Weight	1.834 kg
Unit Type of Package 2	S03
Number of Units in Package 2	3
Package 2 Height	30.000 cm
Package 2 Width	30.000 cm
Package 2 Length	40.000 cm
Package 2 Weight	5.879 kg

Offer Sustainability

Sustainable offer status	Green Premium product
REACH Regulation	 REACH Declaration
EU RoHS Directive	Compliant with Exemptions
Mercury free	Yes
China RoHS Regulation	 China RoHS Declaration
RoHS exemption information	 Yes
Environmental Disclosure	 Product Environmental Profile
Circularity Profile	 End Of Life Information
WEEE	The product must be disposed on European Union markets following specific waste collection and never end up in rubbish bins
PVC free	Yes
Halogen content performance	Halogen free plastic parts product

Contractual warranty

Warranty	18 months
----------	-----------

Tripping Curves for GV4L and GV4LE Combined with Thermal Overload Relay LRD or LR9

Average Operating Times at 20 °C Related to Multiples of the Setting Current

GV4L02 and GV4LE02 to 12 with LRD05 to LRD14, GV4L80 and GV4LE80 with LRD3363

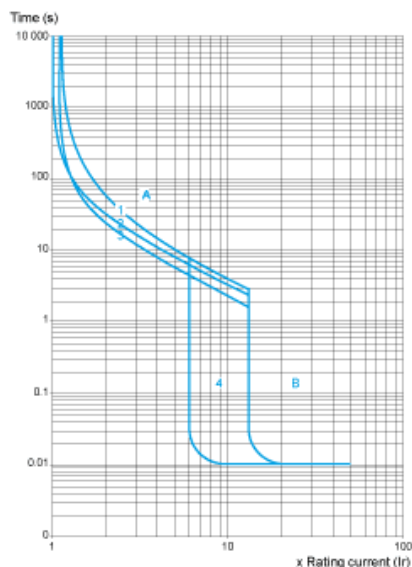

- 1 3 poles from cold state
- 2 2 poles from cold state
- 3 3 poles from hot state
- 4 6...14 Ir
- A Thermal overload relay protection zone
- B GV4L protection zone

GV4L25 and GV4LE25 with LRD 318, LRD325 GV4L50 AND GV4LE50 with LRD 332, LRD 340, LRD 350

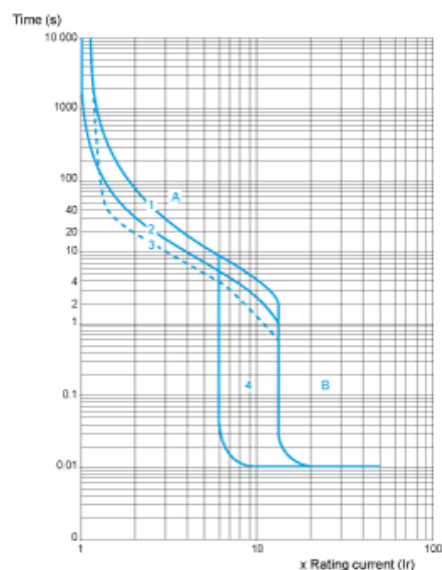

- 1 3 poles from cold state
- 2 2 poles from cold state
- 3 3 poles from hot state
- 4 6...14 Ir
- A Thermal overload relay protection zone
- B GV4L protection zone

GV4L115 and GV4LE115 with Class 10 LR9F5367, LR9D5369 and Class 20 LR9D5567, LR9F5569



- 1 Cold state curve
- 2 Hot state curve
- 3 6...14 Ir

Current Limitation on Short-Circuit for GV4L, GV4LE (3-Phase 400/415 V)

Dynamic Stress

$I_{peak} = f(\text{prospective } I_{sc}) \text{ at } 1.05 U_e = 435 \text{ V}$



- 1 Maximum peak current
- 2 GV4L115
- 3 GV4L80
- 4 GV4L50
- 5 GV4L25
- 6 GV4L12
- 7 GV4L07
- 8 GV4L03
- 9 GV4L02

Current Limitation on Short-Circuit for GV4L, GV4LE + Thermal Overload Relay LRD or LR9 (3-Phase 400/415 V)

Dynamic Stress

$I_{peak} = f(\text{prospective } I_{sc}) \text{ at } 1.05 U_e = 435 \text{ V}$

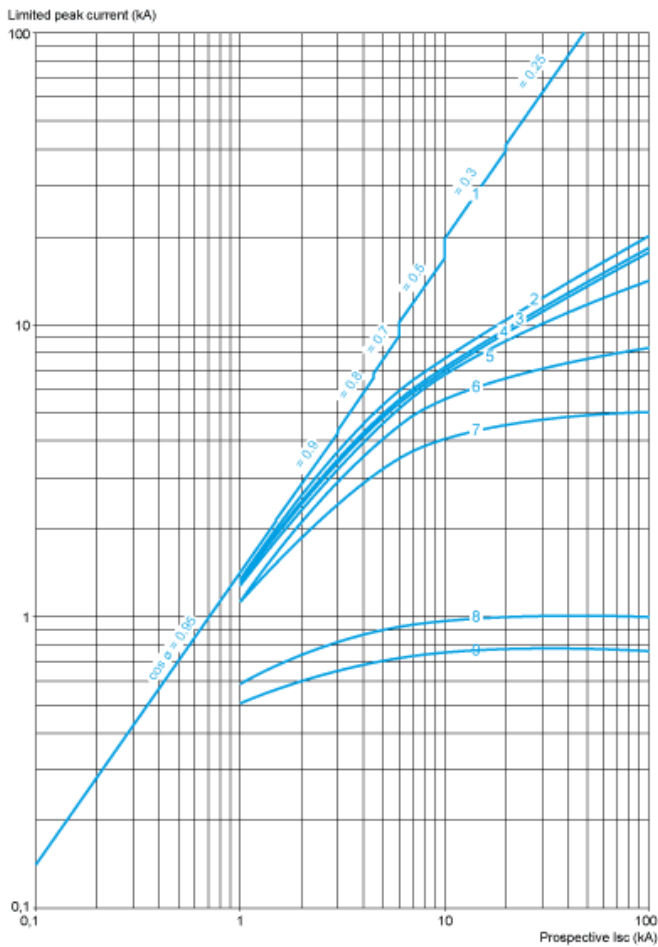

- 1 Maximum peak current
- 2 GV4L115 + LR9D5367 or LR9F5367
- 3 GV4L80 + LRD3361
- 4 GV4L50 + LRD340
- 5 GV4L25 + LRD325
- 6 GV4L12 + LRD313
- 7 GV4L07 + LRD12
- 8 GV4L03 + LRD07
- 9 GV4L02 + LRD07

Thermal Limit on Short-Circuit for GV4L, GV4LE

Thermal Limit in A^2s

$\text{Sum of } I^2dt = f(\text{prospective } I_{sc}) \text{ at } 1.05 U_e = 435 \text{ V}$



- 1 GV4L115
- 2 GV4L80
- 3 GV4L50
- 4 GV4L25
- 5 GV4L12
- 6 GV4L07
- 7 GV4L03
- 8 GV4L02

Current Limitation on Short-Circuit for GV4L, GV4LE + Thermal Overload Relay LRD or LR9

Thermal Limit in kA in the Magnetic Operating Zone

Sum of $I^2dt = f$ (prospective Isc) at $1.05 U_e = 435 V$



- 1 GV4L115 + LR9D5367 or LR9F5367
- 2 GV4L80 + LRD3361
- 3 GV4L50 + LRD340
- 4 GV4L25 + LRD325
- 5 GV4L12 + LRD313
- 6 GV4L07+ LRD12
- 7 GV4L03+ LRD07
- 8 GV4L02 + LRD07

GV4 with Toggle: GV4LE, GV4PE, GV4PEM

With EverLink® Connector

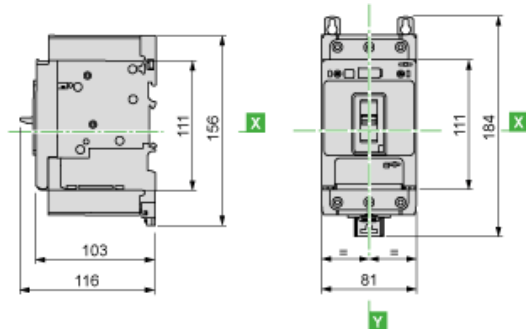

With Crimp Lug Connector

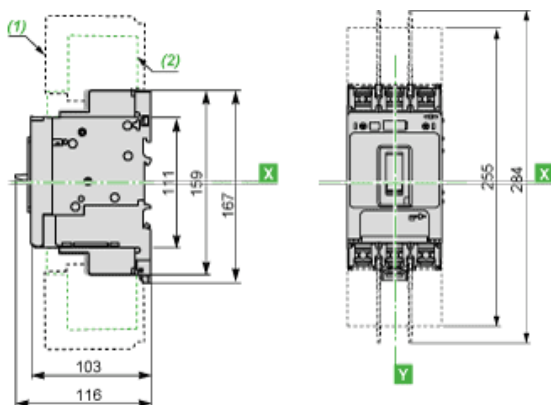

- (1) Interphase barriers
- (2) Long terminal shield

GV4 with Rotary Handle: GV4L, GV4P, or GV4LE, GV4PE, GV4PEM with GV4ADN01, GV4ADN02 Direct Mounting Rotary Handle

Dimensions

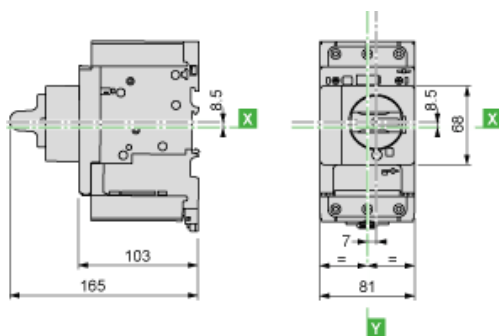

GV4L, GV4P, GV4LE, GV4PE, GV4PEM

Panel Mounting with M4 Screws



Door Cut-Out for Rotary Handle



Minimum Safety Clearance



Toggle-type, rotary handle-type: identical clearance values.

Safety Clearance (mm)						
	Painted Sheet Metal			Bare Sheet Metal		
	A	B	C	A	B	C
No accessory	30	0	0	40	0	5
Interphase barriers	0	0	0	0	0	5
Long terminal shield	0	0	0	0	0	5

Magnetic Motor Circuit Breakers

GV4L, GV4LE

