

GV7RS150

TeSys GV7 Manual Starter and Protector,
thermal magnetic circuit protector, rocker lever,
3 P, AC-3, 90...150 A, high interrupt



Main

Range	TeSys
Product name	TeSys GV7
Product or Component Type	Circuit breaker
Device short name	GV7R
Device Application	Motor
Poles description	3P
Network type	AC
Utilisation category	AC-3 IEC 60947-4-1
Network frequency	50/60 Hz IEC 60947-4-1
Breaking capacity	50 KA Icu 500 V AC 50/60 Hz IEC 60947-2 65 KA Icu 440 V AC 50/60 Hz IEC 60947-2 100 KA Icu 220/240 V AC 50/60 Hz IEC 60947-2 70 KA Icu 380/415 V AC 50/60 Hz IEC 60947-2 10 kA Icu 660/690 V AC 50/60 Hz IEC 60947-2
[Ics] rated service short-circuit breaking capacity	100 % 440 V AC 50/60 Hz IEC 60947-2 100 % 500 V AC 50/60 Hz IEC 60947-2 100 % 220/240 V AC 50/60 Hz IEC 60947-2 100 % 380/415 V AC 50/60 Hz IEC 60947-2 100 % 660/690 V AC 50/60 Hz IEC 60947-2
Thermal protection adjustment range	90...150 A
Trip unit technology	Thermal-magnetic

Complementary

Mounting Mode	By clips By screws
Mounting Support	Flush Rail Panel mounting Kit for fixing the switchgear
Mounting position	Vertical
Motor power kW	110 KW 660...690 V AC 50/60 Hz 55 KW 400...415 V AC 50/60 Hz 75 KW 400...415 V AC 50/60 Hz 75 KW 500 V AC 50/60 Hz 90 KW 500 V AC 50/60 Hz 90 kW 660...690 V AC 50/60 Hz
Control Type	Rocker lever
[Ue] rated operational voltage	690 V AC 50/60 Hz IEC 60947-2
[Ui] rated insulation voltage	750 V AC 50/60 Hz IEC 60947-2
[Ith] conventional free air thermal current	150 A IEC 60947-4-1
[Uimp] rated impulse withstand voltage	8 kV IEC 60947-2
Power dissipation per pole	8.7 W
Power dissipation per pole	8.7 W
Mechanical durability	40000 cycles
Electrical durability	20000 Cycles AC-3 440 V In 40000 cycles AC-3 440 V In/2
Maximum operating rate	25 cyc/h
Rated duty	Continuous IEC 60947-4-1
Connection pitch	1.38 In (35 mm) without spreaders 1.77 in (45 mm) with spreaders

Connections - terminals	Bars Cable with lug 0.39 in (10 mm) Screw Bare cable connectors 0.00...0.15 in ² (1.5...95 mm ²)
Tightening torque	88.51 Lbf.in (10 N.m) screw M6 132.76 lbf.in (15 N.m) bare cable connectors 0.00...0.15 in ² (1.5...95 mm ²)
Mechanical robustness	Shocks 15 Gn for 11 ms IEC 60068-2-27 Vibrations 2.5 Gn, 0...25 Hz IEC 60068-2-6
Suitability for isolation	Yes IEC 60947-1
Phase failure sensitivity	Yes IEC 60947-4-1 § 7-2-1-5-2
Height	6.34 in (161 mm)
Width	4.13 in (105 mm)
Depth	4.37 in (111 mm)
Net Weight	4.45 lb(US) (2.02 kg)

Environment

Standards	NF C 63-650 EN/IEC 60947-2 NF C 63-120 EN/IEC 60947-4-1 VDE 0113 NF C 79-130 VDE 0660 EN/IEC 60947-1
Product Certifications	UL DNV
Protective treatment	TC
IP degree of protection	IP405 IEC 60529 with terminal shrouds)
Pollution degree	3
Ambient air temperature for operation	-13...158 °F (-25...70 °C)
Ambient Air Temperature for Storage	-67...203 °F (-55...95 °C)
Fire resistance	1760 °F (960 °C) IEC 60695-2-1
Operating altitude	6561.68 ft (2000 m)

Ordering and shipping details

Category	22366-MAN STR PROTECTORS-GV1/GV3
Discount Schedule	I11
GTIN	3389110566871
Nbr. of units in pkg.	1
Package weight(Lbs)	4.32 lb(US) (1.958 kg)
Returnability	No
Country of origin	CN

Packing Units

Unit Type of Package 1	PCE
Package 1 Height	4.33 in (11.0 cm)
Package 1 width	5.51 in (14.0 cm)
Package 1 Length	6.89 in (17.5 cm)

Offer Sustainability

EU RoHS Directive	Not applicable, out of EU RoHS legal scope
Environmental Disclosure	Product Environmental Profile

Contractual warranty

Warranty	18 months
----------	-----------

Current Limitation on Short-Circuit (3-Phase 400/415 V)

Dynamic Stress

$I_{peak} = f(\text{prospective } I_{sc})$

For GV7RS only

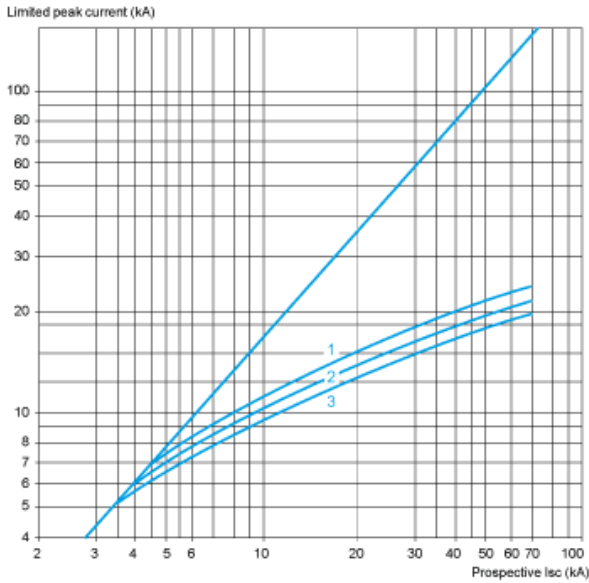

- 1 GV7RS220
- 2 GV7RS150
- 3 GV7RS100

Thermal Limit (3-Phase 400/415 V)

Thermal Limit

Sum of $I^2dt = f(\text{prospective } I_{sc})$

For GV7RS only

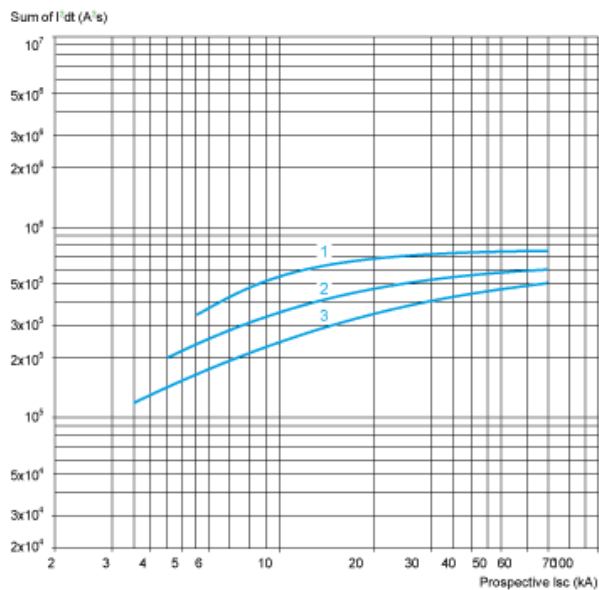

- 1 GV7RS220
- 2 GV7RS150
- 3 GV7RS100

Current Limitation on Short-Circuit (3-Phase 690 V)

Dynamic Stress

$I_{peak} = f(\text{prospective } I_{sc})$

For GV7RS only

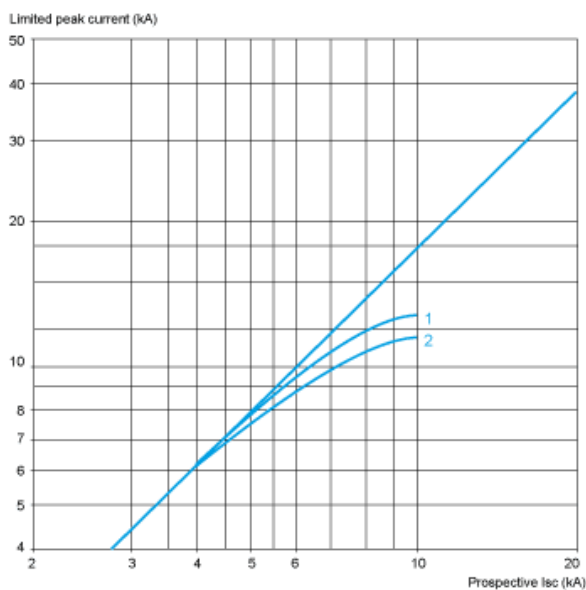

- 1 GV7RS220
- 2 GV7RS150 and GV7RS100

Thermal Limit on Short-Circuit (3-Phase 690 V)

Thermal Limit

$\text{Sum of } I^2 dt = f(\text{prospective } I_{sc})$

For GV7RS only

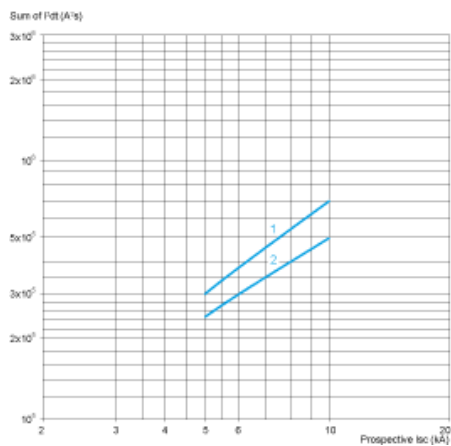

- 1 GV7RS220
- 2 GV7RS150 and GV7RS100

GV7R

Dimensions

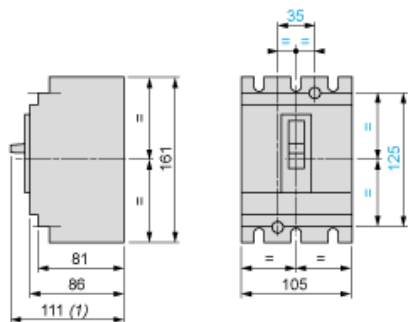

(1) 126 for GV7R.220.

Minimum Electrical Clearance

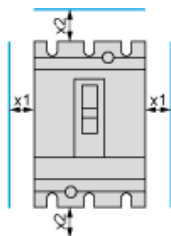

		x1	x2
Painted or insulated metal plate, insulation or insulated bar		0	30
Bare metal plate	$U \leq 440 \text{ V}$	5	35
$440 \text{ V} < U < 600 \text{ V}$		35	
$U \geq 600 \text{ V}$		35	

GV7R

Panel Mounting

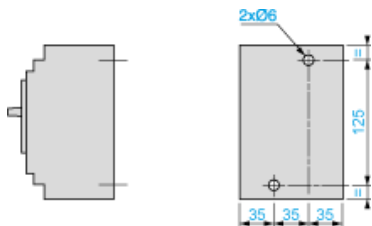

Mounting on 2 Mounting Rails DZ5 MB201

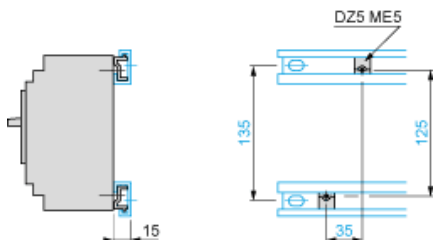

Flush-Mounting

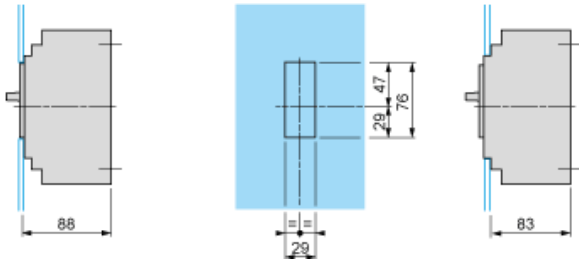

1 circuit breaker GV7R

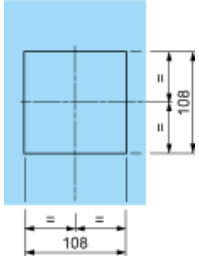

n circuit breakers GV7R side by side

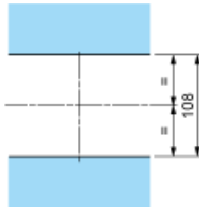

Connection

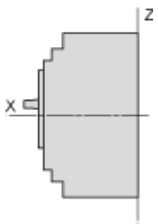

Smooth terminals

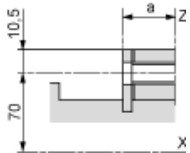

	a
GV7R.40...R.150	19.5
GV7R.220	21.5

Connectors

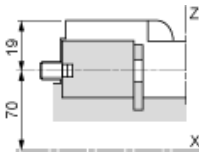

Motor Circuit Breakers

GV7 R

