



## Main

Range of product	Modicon M221
Product or component type	Logic controller
[Us] rated supply voltage	100...240 V AC
Discrete input number	24, discrete input conforming to IEC 61131-2 Type 1
Analogue input number	2 at 0...10 V
Discrete output type	Relay normally open
Discrete output number	16 relay
Discrete output voltage	5...125 V DC 5...250 V AC
Discrete output current	2 A

## Complementary

Discrete I/O number	40
Maximum number of I/O expansion module	7 (local I/O-Architecture) 14 (remote I/O-Architecture)
Supply voltage limits	85...264 V
Network frequency	50/60 Hz
Inrush current	40 A
Maximum power consumption in VA	70 VA at 100...240 V with max number of I/O expansion module 41 VA at 100...240 V without I/O expansion module
Power supply output current	0.52 A 5 V for expansion bus 0.24 A 24 V for expansion bus
Discrete input logic	Sink or source (positive/negative)
Discrete input voltage	24 V
Discrete input voltage type	DC
Analogue input resolution	10 bits
LSB value	10 mV
Conversion time	1 ms per channel + 1 controller cycle time for analogue input analog input
Permitted overload on inputs	+/- 30 V DC for 5 min (maximum) for analog input +/- 13 V DC (permanent) for analog input
Voltage state 1 guaranteed	>= 15 V for input
Voltage state 0 guaranteed	<= 5 V for input
Discrete input current	7 MA for discrete input 5 mA for fast input
Input impedance	3.4 kOhm for discrete input 100 kOhm for analog input 4.9 kOhm for fast input
Response time	35 µs turn-off, I2...I5 terminal(s) for input 10 ms turn-on for output 10 ms turn-off for output 5 µs turn-on, I0, I1, I6, I7 terminal(s) for fast input 35 µs turn-on, other terminals terminal(s) for input 5 µs turn-off, I0, I1, I6, I7 terminal(s) for fast input 100 µs turn-off, other terminals terminal(s) for input
Configurable filtering time	0 ms for input 3 ms for input 12 ms for input
Output voltage limits	125 V DC 277 V AC

The information provided in this documentation contains general descriptions and/or technical characteristics of the performance of the products contained herein. This documentation is not intended as a substitute for and is not to be used for determining suitability or reliability of these products for specific user applications. It is the duty of any such user or integrator to perform the appropriate and complete risk analysis, evaluation and testing of the products with respect to the relevant specific application or use thereof. Neither Schneider Electric Industries SAS nor any of its affiliates or subsidiaries shall be responsible or liable for misuse of the information contained herein.

Maximum current per output common	7 A
Absolute accuracy error	+/- 1 % of full scale for analog input
Electrical durability	100000 Cycles AC-12, 120 V, 240 VA, resistive 100000 Cycles AC-12, 240 V, 480 VA, resistive 300000 Cycles AC-12, 120 V, 80 VA, resistive 300000 Cycles AC-12, 240 V, 160 VA, resistive 100000 Cycles AC-15, cos phi = 0.35, 120 V, 60 VA, inductive 100000 Cycles AC-15, cos phi = 0.35, 240 V, 120 VA, inductive 300000 Cycles AC-15, cos phi = 0.35, 120 V, 18 VA, inductive 300000 Cycles AC-15, cos phi = 0.35, 240 V, 36 VA, inductive 100000 Cycles AC-14, cos phi = 0.7, 120 V, 120 VA, inductive 100000 Cycles AC-14, cos phi = 0.7, 240 V, 240 VA, inductive 300000 Cycles AC-14, cos phi = 0.7, 120 V, 36 VA, inductive 300000 Cycles AC-14, cos phi = 0.7, 240 V, 72 VA, inductive 100000 Cycles DC-12, 24 V, 48 W, resistive 300000 Cycles DC-12, 24 V, 16 W, resistive 100000 Cycles DC-13, 24 V, 24 W, inductive (L/R = 7 ms) 300000 cycles DC-13, 24 V, 7.2 W, inductive (L/R = 7 ms)
Switching frequency	20 switching operations/minute with maximum load
Mechanical durability	20000000 cycles for relay output
Minimum load	1 mA at 5 V DC for relay output
Protection type	Without protection at 5 A
Reset time	1 s
Memory capacity	256 kB for user application and data RAM with 10000 instructions 256 kB for internal variables RAM
Data backed up	256 kB built-in flash memory for backup of application and data
Data storage equipment	2 GB SD card (optional)
Battery type	BR2032 or CR2032X lithium non-rechargeable
Backup time	1 year at 25 °C (by interruption of power supply)
Execution time for 1 KInstruction	0.3 ms for event and periodic task
Execution time per instruction	0.2 µs Boolean
Exct time for event task	60 µs response time
Maximum size of object areas	8000 %MW memory words 255 %TM timers 512 %KW constant words 255 %C counters 512 %M memory bits
Realtime clock	With
Clock drift	<= 30 s/month at 25 °C
Regulation loop	Adjustable PID regulator up to 14 simultaneous loops
Counting input number	4 fast input (HSC mode) at 100 kHz 32 bits
Counter function	Single phase A/B Pulse/direction
Integrated connection type	USB port with mini B USB 2.0 connector Non isolated serial link serial 1 with RJ45 connector and RS232/RS485 interface Ethernet with RJ45 connector
Supply	(serial)serial link supply: 5 V, <200 mA
Transmission rate	1.2...115.2 kbit/s (115.2 kbit/s by default) for bus length of 15 m for RS485 1.2...115.2 kbit/s (115.2 kbit/s by default) for bus length of 3 m for RS232 480 Mbit/s for USB
Communication port protocol	USB port: USB - SoMachine-Network Non isolated serial link: Modbus master/slave - RTU/ASCII or SoMachine-Network Ethernet
Port Ethernet	10BASE-T/100BASE-TX 1 port with 100 m copper cable
Communication service	DHCP client Modbus TCP client Ethernet/IP adapter Modbus TCP server Modbus TCP slave device

Local signalling	<p>1 LED (green) for PWR  1 LED (green) for RUN  1 LED (red) for module error (ERR)  1 LED (green) for SD card access (SD)  1 LED (red) for BAT  1 LED per channel (green) for I/O state  1 LED (green) for SL  Ethernet network activity (green) for ACT  Ethernet network link (yellow) for Link (Link Status)</p>
Electrical connection	<p>Removable screw terminal block for inputs  Removable screw terminal block for outputs  Terminal block, 3 terminal(s) for connecting the 24 V DC power supply  Connector, 4 terminal(s) for analogue inputs  Mini B USB 2.0 connector for a programming terminal</p>
Maximum cable distance between devices	<p>Shielded cable: &lt;10 m for fast input  Unshielded cable: &lt;30 m for output  Unshielded cable: &lt;30 m for digital input  Unshielded cable: &lt;1 m for analog input</p>
Insulation	<p>Between input and internal logic at 500 V AC  Non-insulated between analogue input and internal logic  Non-insulated between analogue inputs  Between supply and ground at 1500 V AC  Between sensor power supply and ground at 500 V AC  Between input and ground at 500 V AC  Between output and ground at 1500 V AC  Between supply and internal logic at 2300 V AC  Between sensor power supply and internal logic at 500 V AC  Between output and internal logic at 2300 V AC  Between Ethernet terminal and internal logic at 500 V AC  Between supply and sensor power supply at 2300 V AC</p>
Marking	CE
Sensor power supply	24 V DC at 250 mA supplied by the controller
Mounting support	<p>Top hat type TH35-15 rail conforming to IEC 60715  Top hat type TH35-7.5 rail conforming to IEC 60715  Plate or panel with fixing kit</p>
Height	90 mm
Depth	70 mm
Width	160 mm
Net weight	0.456 kg

## Environment



Standards	<p>IEC 61131-2  UL 508  CAN/CSA C22.2 No. 213  IACS E10  ANSI/ISA 12-12-01</p>
Product certifications	<p>DNV-  GL[RETURN]EAC[RETURN]ABS[RETURN]cULus[RETURN]LR[RETURN]RCM[RETURN]CE[  HazLoc</p>
Environmental characteristic	Ordinary and hazardous location
Resistance to electrostatic discharge	<p>8 kV in air conforming to IEC 61000-4-2  4 kV on contact conforming to IEC 61000-4-2</p>
Resistance to electromagnetic fields	<p>10 V/M 80 MHz...1 GHz conforming to IEC 61000-4-3  3 V/M 1.4 GHz...2 GHz conforming to IEC 61000-4-3  1 V/m 2...2.7 GHz conforming to IEC 61000-4-3</p>
Resistance to magnetic fields	30 A/m 50/60 Hz conforming to IEC 61000-4-8
Resistance to fast transients	<p>2 kV (power lines) conforming to IEC 61000-4-4  2 kV (relay output) conforming to IEC 61000-4-4  1 kV (I/O) conforming to IEC 61000-4-4  1 kV (Ethernet line) conforming to IEC 61000-4-4  1 kV (serial link) conforming to IEC 61000-4-4</p>
Surge withstand	<p>2 kV power lines (AC) common mode conforming to IEC 61000-4-5  2 kV relay output common mode conforming to IEC 61000-4-5  1 kV I/O common mode conforming to IEC 61000-4-5  1 kV shielded cable common mode conforming to IEC 61000-4-5  0.5 kV power lines (DC) differential mode conforming to IEC 61000-4-5  1 kV power lines (AC) differential mode conforming to IEC 61000-4-5  1 kV relay output differential mode conforming to IEC 61000-4-5  0.5 kV power lines (DC) common mode conforming to IEC 61000-4-5</p>

Resistance to conducted disturbances	10 V 0.15...80 MHz conforming to IEC 61000-4-6 3 V 0.1...80 MHz conforming to Marine specification (LR, ABS, DNV, GL) 10 V spot frequency (2, 3, 4, 6.2, 8.2, 12.6, 16.5, 18.8, 22, 25 MHz) conforming to Marine specification (LR, ABS, DNV, GL)
Electromagnetic emission	Conducted emissions - test level: 79 dB $\mu$ V/m QP/66 dB $\mu$ V/m AV ( power lines (AC)) at 0.15...0.5 MHz conforming to IEC 55011 Conducted emissions - test level: 73 dB $\mu$ V/m QP/60 dB $\mu$ V/m AV ( power lines (AC)) at 0.5...300 MHz conforming to IEC 55011 Conducted emissions - test level: 120...69 dB $\mu$ V/m QP ( power lines) at 10...150 kHz conforming to IEC 55011 Conducted emissions - test level: 63 dB $\mu$ V/m QP ( power lines) at 1.5...30 MHz conforming to IEC 55011 Radiated emissions - test level: 40 dB $\mu$ V/m QP class A ( 10 m) at 30...230 MHz conforming to IEC 55011 Conducted emissions - test level: 79...63 dB $\mu$ V/m QP ( power lines) at 150...1500 kHz conforming to IEC 55011 Radiated emissions - test level: 47 dB $\mu$ V/m QP class A ( 10 m) at 200...1000 MHz conforming to IEC 55011
Immunity to microbreaks	10 ms
Ambient air temperature for operation	-10...55 °C (horizontal installation) -10...35 °C (vertical installation)
Ambient air temperature for storage	-25...70 °C
Relative humidity	10...95 %, without condensation (in operation) 10...95 %, without condensation (in storage)
IP degree of protection	IP20 with protective cover in place
Pollution degree	<= 2
Operating altitude	0...2000 m
Storage altitude	0...3000 m
Vibration resistance	3.5 mm at 5...8.4 Hz on symmetrical rail 3.5 mm at 5...8.4 Hz on panel mounting 1 gn at 8.4...150 Hz on symmetrical rail 1 gn at 8.4...150 Hz on panel mounting
Shock resistance	98 m/s <sup>2</sup> for 11 ms

## Packing Units

Unit Type of Package 1	PCE
Number of Units in Package 1	1
Package 1 Height	11.09 cm
Package 1 Width	14.183 cm
Package 1 Length	21.085 cm
Package 1 Weight	830.0 g
Unit Type of Package 2	CAR
Number of Units in Package 2	12
Package 2 Height	29.2 cm
Package 2 Width	39.8 cm
Package 2 Length	57.9 cm
Package 2 Weight	11.04 kg
Unit Type of Package 3	P12
Number of Units in Package 3	144
Package 3 Height	105.0 cm
Package 3 Width	120.0 cm
Package 3 Length	80.0 cm
Package 3 Weight	145 kg

## Offer Sustainability

Sustainable offer status	Green Premium product
REACH Regulation	 <a href="#">REACH Declaration</a>
EU RoHS Directive	Pro-active compliance (Product out of EU RoHS legal scope)
Mercury free	Yes
China RoHS Regulation	 <a href="#">China RoHS Declaration</a>
RoHS exemption information	 Yes

Environmental Disclosure	<a href="#">Product Environmental Profile</a>
Circularity Profile	<a href="#">End Of Life Information</a>
WEEE	The product must be disposed on European Union markets following specific waste collection and never end up in rubbish bins
PVC free	Yes
California proposition 65	WARNING: This product can expose you to chemicals including: Lead and lead compounds, which is known to the State of California to cause cancer and birth defects or other reproductive harm. For more information go to <a href="http://www.P65Warnings.ca.gov">www.P65Warnings.ca.gov</a>

Dimensions

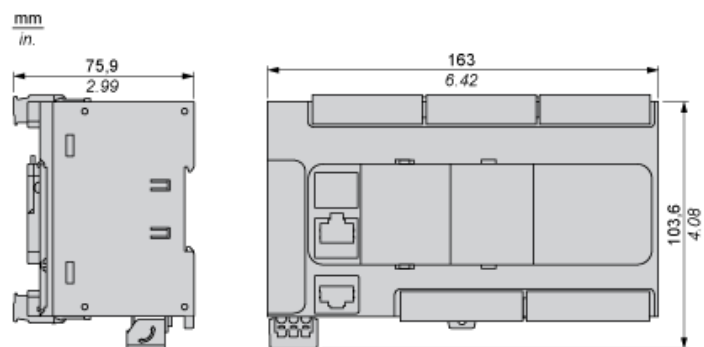

Mounting on a Rail

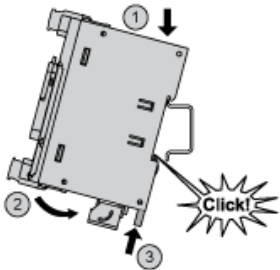

Direct Mounting on a Panel Surface

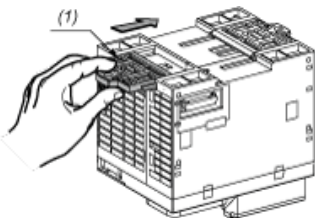

- (1) Install a mounting strip

Mounting Hole Layout

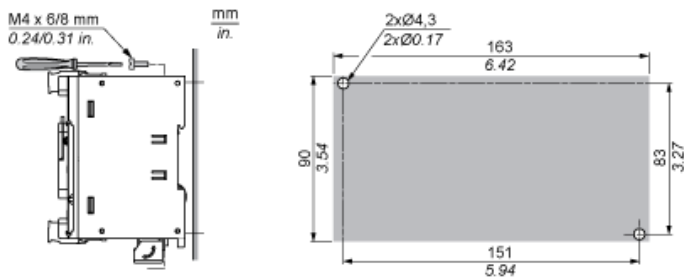

Mounting

Correct Mounting Position

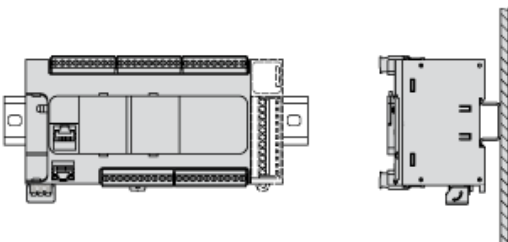

## Acceptable Mounting Position

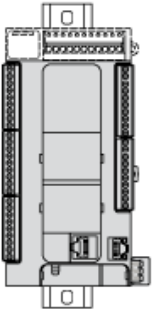

## Incorrect Mounting Position

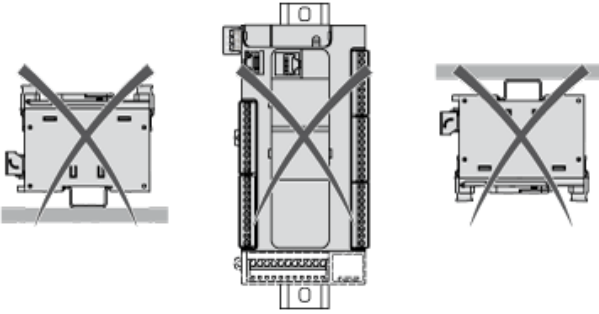

## Clearance

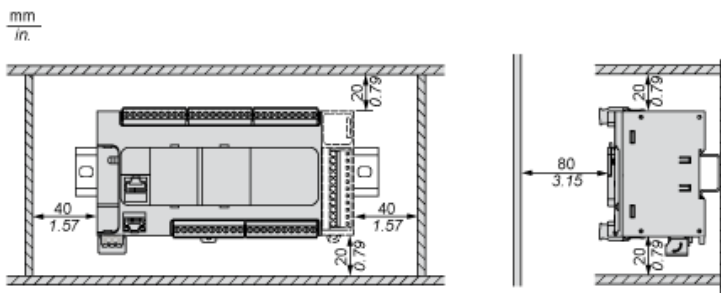



Digital Inputs

Wiring Diagram (Positive Logic)

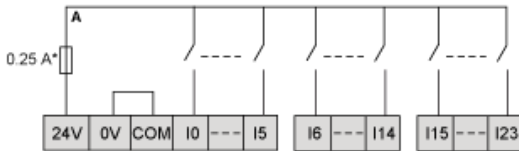

(\*) Type T fuse

Wiring Diagram (Negative Logic)

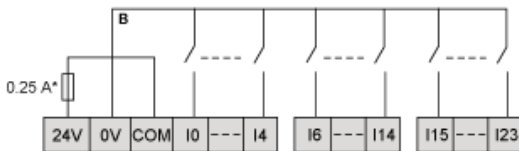

(\*) Type T fuse

Connection of the Fast Inputs

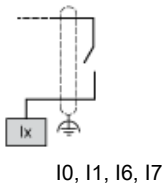

Relay Outputs

Negative Logic (Sink)

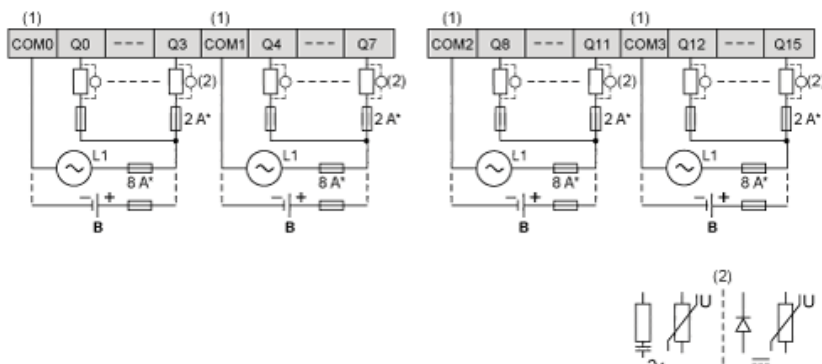

(\*) Type T fuse

(1) The COM0, COM1, COM2 and COM3 terminals are not connected internally.

(2) To improve the life time of the contacts, and to protect from potential inductive load damage, you must connect a free wheeling diode in parallel to each inductive DC load or an RC snubber in parallel of each inductive AC load

B Sink wiring (negative logic)

## Positive Logic (Source)

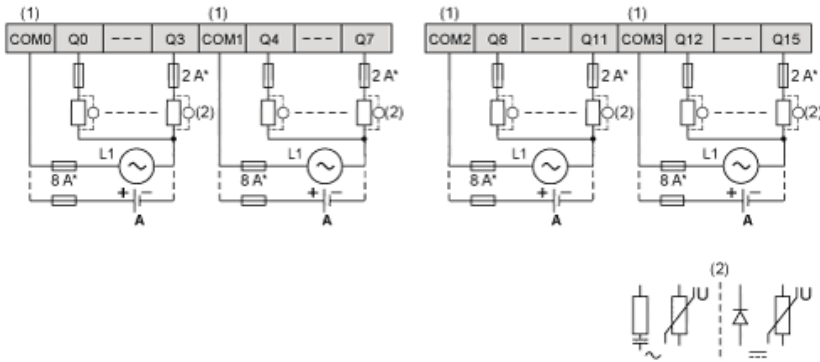

- (\*) Type T fuse
- (1) The COM0, COM1, COM2 and COM3 terminals are not connected internally.
- (2) To improve the life time of the contacts, and to protect from potential inductive load damage, you must connect a free wheeling diode in parallel to each inductive DC load or an RC snubber in parallel of each inductive AC load
- A Source wiring (positive logic)

## Analog Inputs

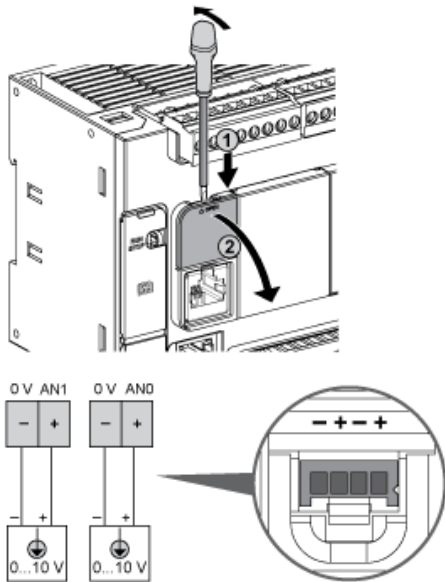

The (-) poles are connected internally.

Pin	Wire Color
0 V	Black
AN1	Red
0 V	Black
AN0	Red

## Ethernet Connection

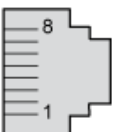

Pin N°	Signal
1	TD+
2	TD-
3	RD+
4	-

Pin N°	Signal
5	-
6	RD-
7	-
8	-

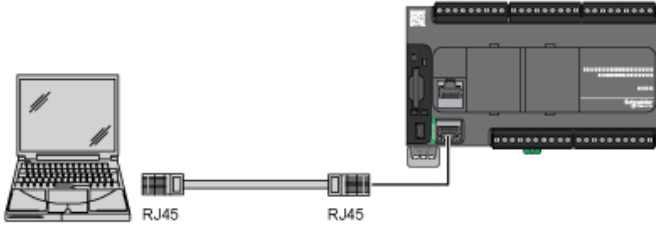

### USB Mini-B Connection

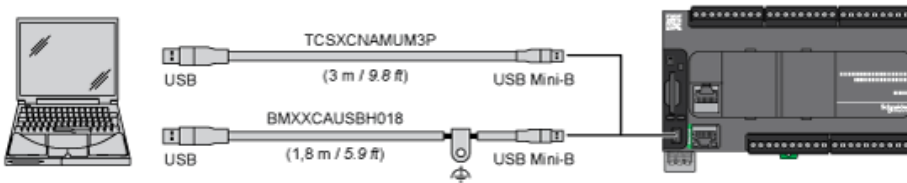

### SL1 Connection

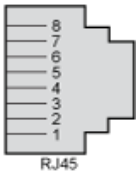

#### SL1

N °	RS 232	RS 485
1	RxD	N.C.
2	TxD	N.C.
3	RTS	N.C.
4	N.C.	D1
5	N.C.	D0
6	CTS	N.C.
7	N.C.*	5 Vdc
8	Common	Common

N.C.: not connected

\* : 5 Vdc delivered by the controller. Do not connect.

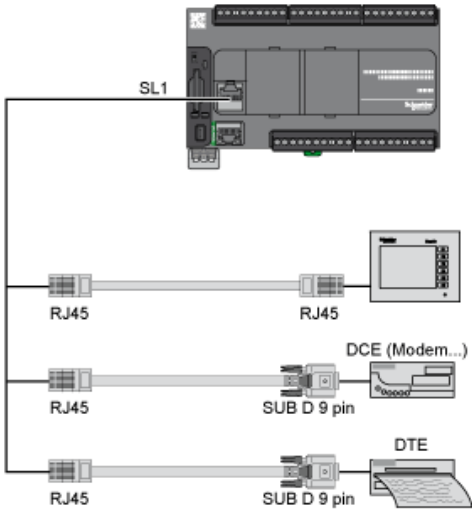

Derating Curves

Embedded Digital Inputs (No Cartridge)

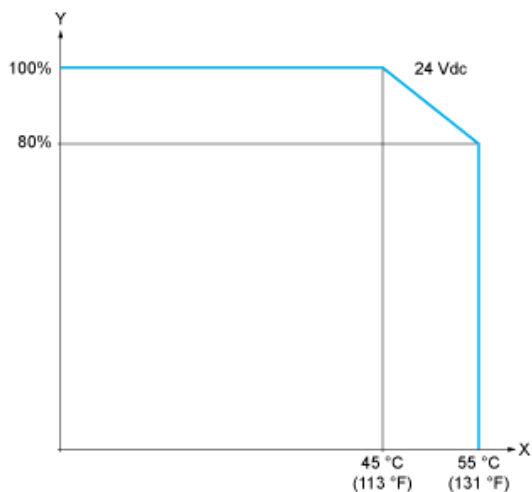

X : Ambient temperature  
Y : Input simultaneous ON ratio

Embedded Digital Inputs (with Cartridge)

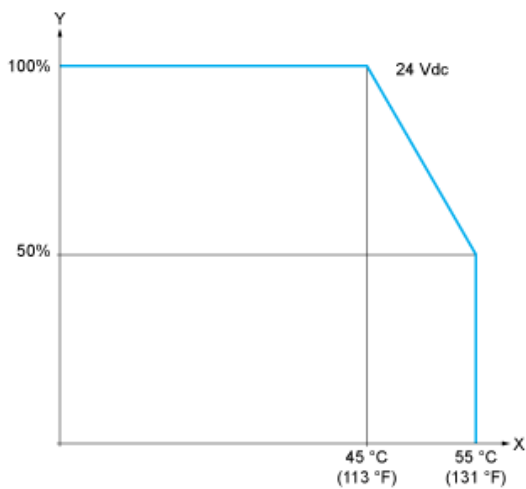

X : Ambient temperature  
Y : Input simultaneous ON ratio